

LKZ: 80262

Modellname/Model name/Nom du modèle/Modellnamn
 Nome modello/Název modelu/Modelnaam/Ime
 modelu/Numéro Modello/Modell neve/Название
 модели/Názov modelu/Ime modela/Denumire
 model/Наименование на модела/NAZwa modelu

ECHO

Modellnummer/Number/Numéro du modèle
 Numero/Номер на модела/modello
 Číslo modelu/Modell száma/Ātīslu modelu
 Številka modela/Număr model/Broj modela
 Modelnummer/Numer modelu

1913-641-00 □

Type/Tipo/Tipus/Typ/Тип/Tip

641

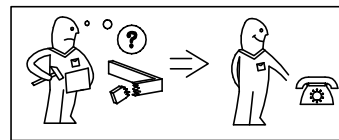
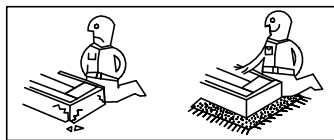
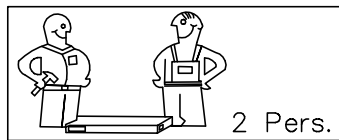
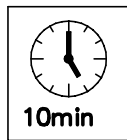

1913-035-92

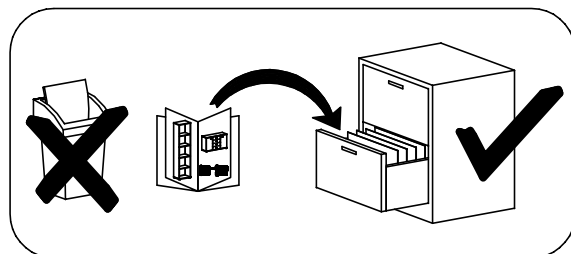
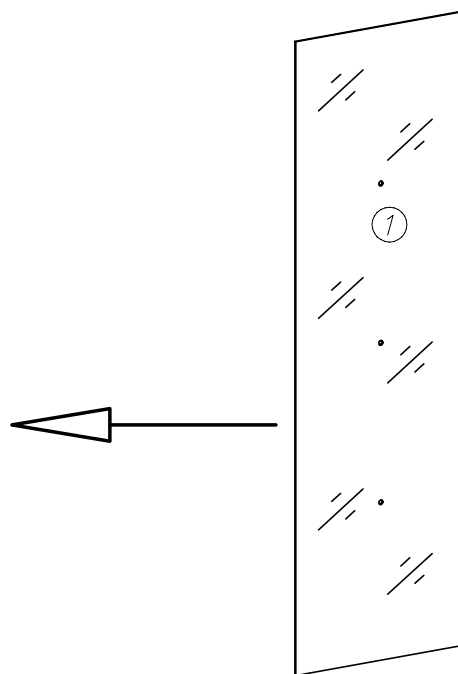
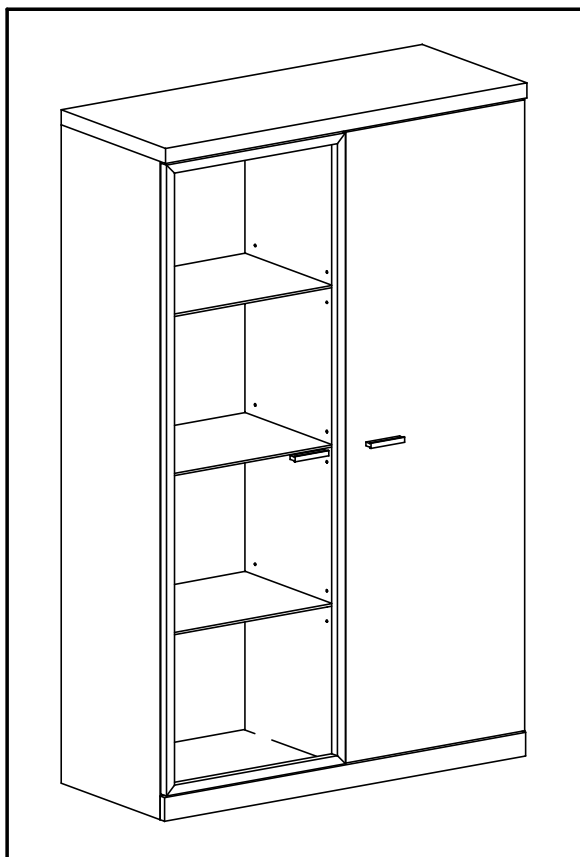

Colli 1/1

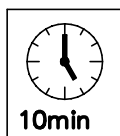
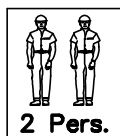
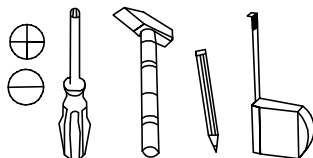

festziehen / tighten / Затягивать /
 serrer / stringere / utåhnut / vastrækken /
 zategniti / stringere / związac / zaciągac /
 szorosan meghúzni / pevno dotiahnut
 trdno pritegniti / затянуть / dro et



eindrücken / press in / enfoncer / wciąć
 ribatters / zatlac / Вжопать / indrukken
 benyomni / stlačit / vtiisiti / tryck in
 introducere prin apăşare / вдавить



ausmessen / measure / mäsurer /
 misurare / opmeten / izmeriti / miera /
 kimēmi / izmeriti / mäsurare / измерить
 změřit / Измеряте / mät upp / zmierzyc



drücken / press / presser / stisknout /
 Hanovete / vtiisiti / nacinae / drücken /
 pritanuti / nacinae / pritaniti / нажать /
 (meg)nyomni / apăşare / tryck fast / nacinae



einschlagen / hammer in / beværni / sla in
 fropper au marteau / infossare / Zabit' /
 zarazit / Hašvete / zabiti / vbic
 introducere prin bătăie / забить / zatlouct



Drehen - wenden / przekręcić - odwrócić /
 Keren - amdraaien / Girare - Ruotare /
 Okrenuti - ubnuti / Retourner - renverser /
 Turn over - turn around / Otocite - obratite /
 Завърте - обвърте / Obmite list /
 Intoarceti - rotiti / Vrid runt - vänd /
 прокрутить - павяртыць / otočit - obrátit
 elforgatni - megfordítani

1

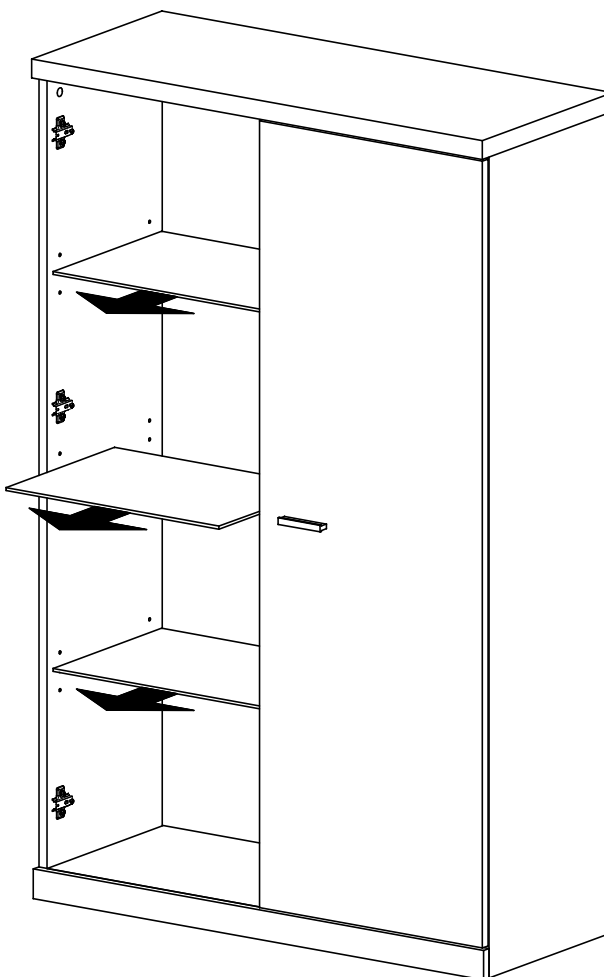

2

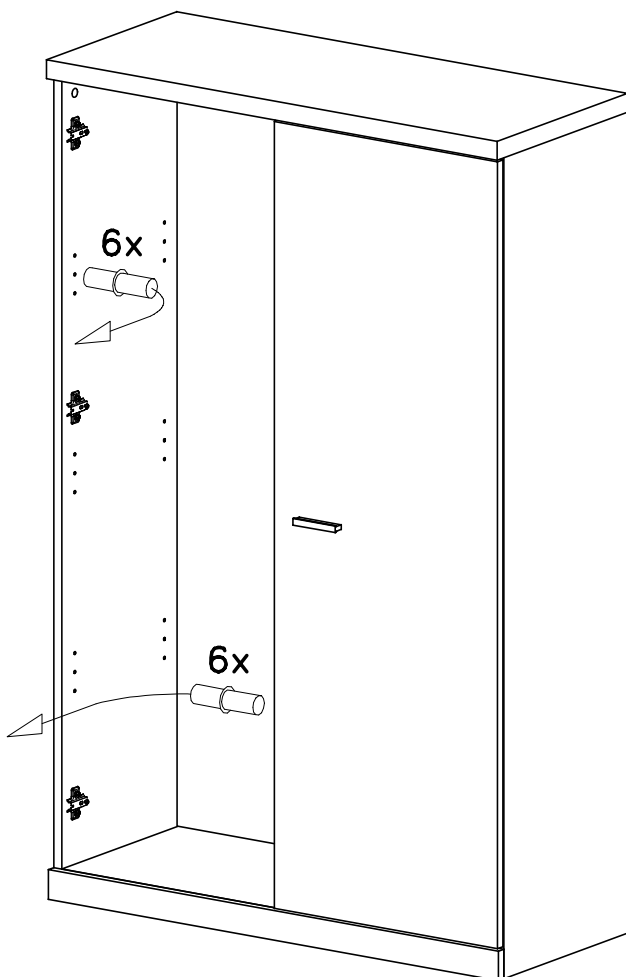

3

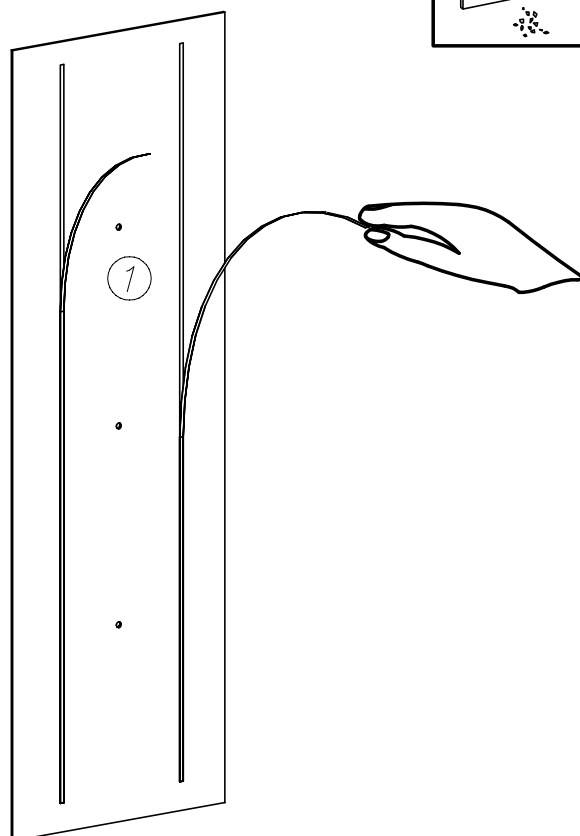
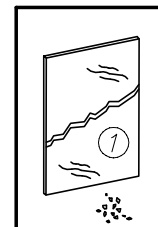
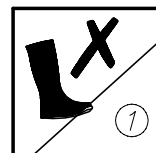

4

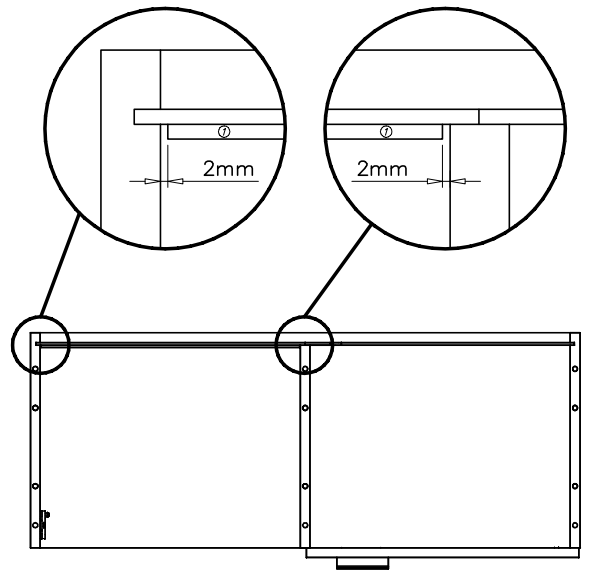
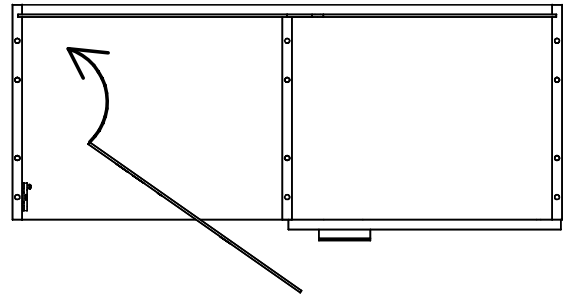
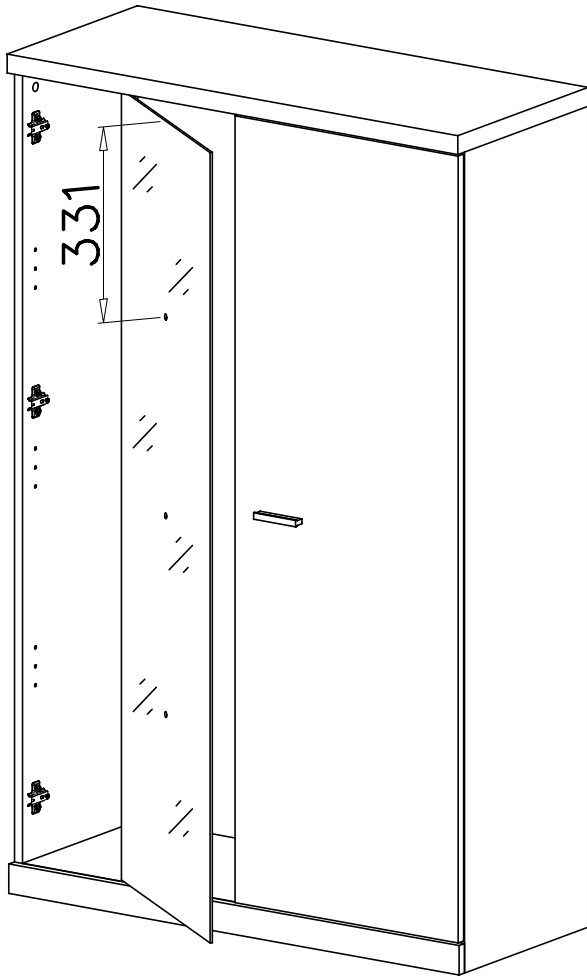

5

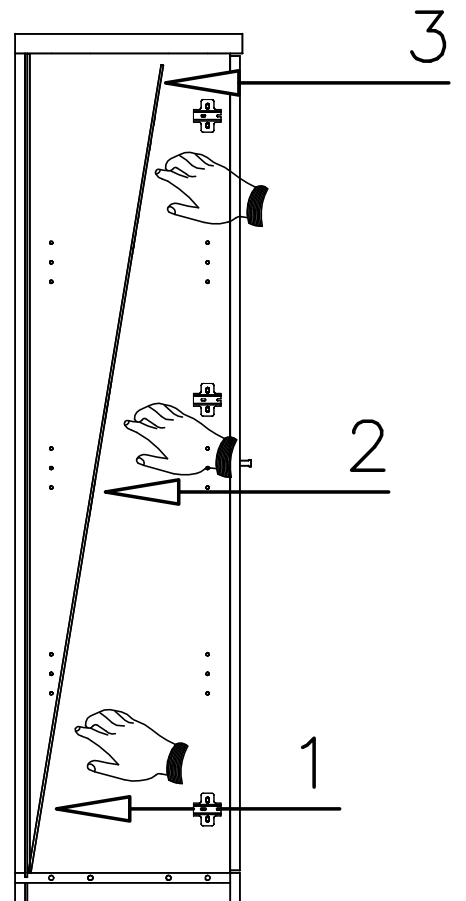
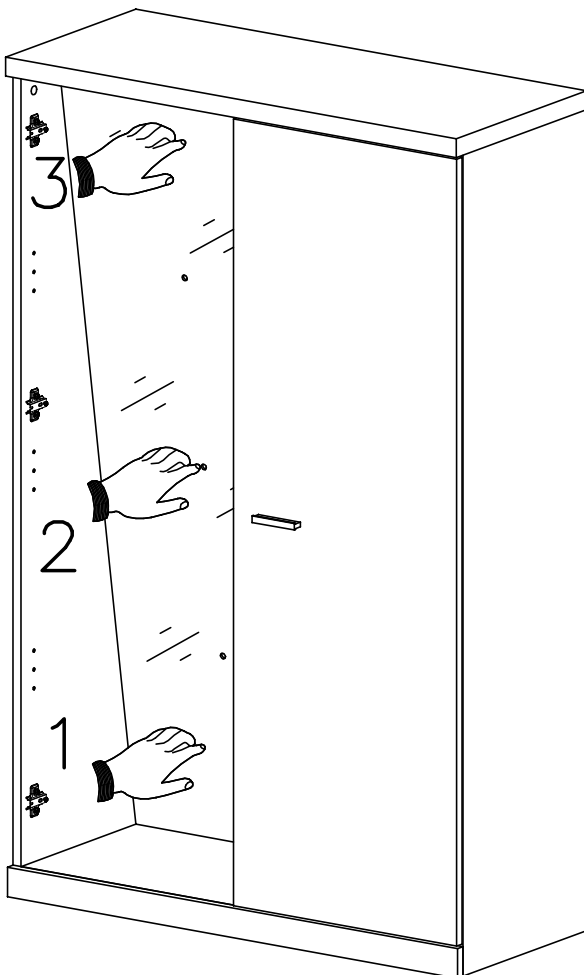

6

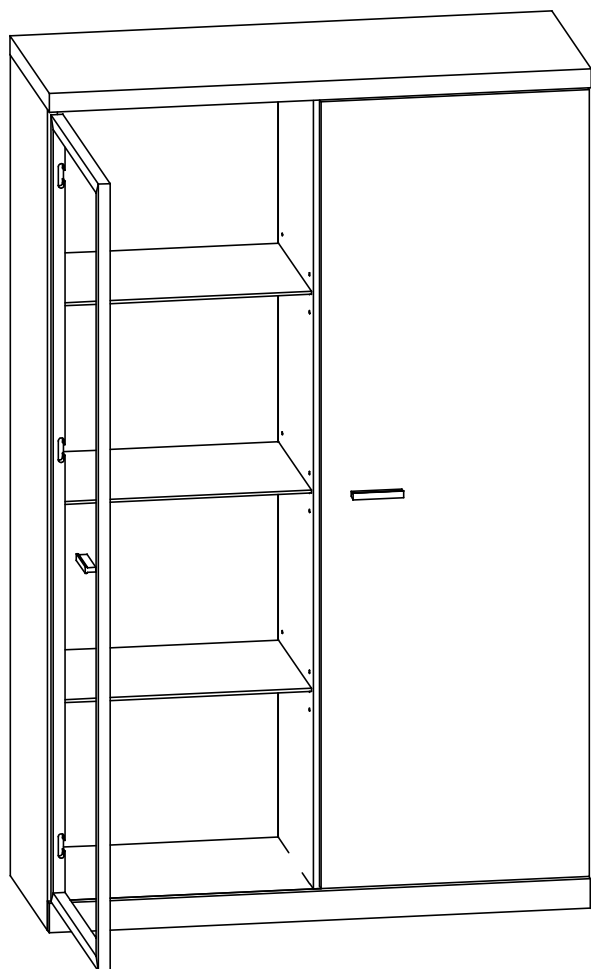

1

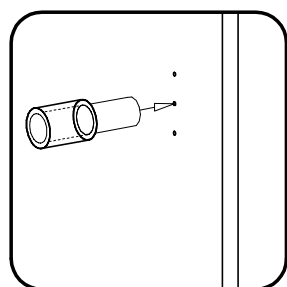

2

