

Montageanleitung / Installation instructions / Instruction de montage / Indicazioni di montaggio / номер модели / Monteringsanvisningar / Montage-instructie / Uputa za montažu / Návod k montáži / Инструкция за монтаж / Instrukcja montażu / Návod na montáž / Navodila za montažo / Instrucțiune de montaj / Инструкция по монтажу / Instrucciones de montaje / Montaj Talimatı

Modellname / Model name / Nom du modele / Model-Imam / Nome modello / Název modelu / Modelnaam / Ime modela / Número Modelo / Modell neve / Название модели / Názov modelu / Ime modela / Denumire model / Наименование на модела / Nazwa modelu

Modellnummer / Number / Numéro du modele / Numero modello / Номер на модела / Èislo modelu / Modell száma / Eíslo modelu / Številka modela / Număr model / Broj modela / Modelnummer / Numer modelu

Type / Tipo / Tipus / Тип / Тип / Tip

# INFINITY

# 1952-70721

# 707

**DE** Unser Direktservice für Beschlagteile  
Sollte Ihnen ein Beschlagteil fehlen, können Sie diese Servicekarte direkt an die untenstehende Adresse mailen. Wir können allerdings nur Beschlagteile auf diesem Wege verschicken. Sollten Sie eine andere Beanstandung an Ihrem Möbelstück haben, so wenden Sie sich bitte direkt an Ihr Möbelhaus.

**EN** Our direct order service for fitting  
If a fitting part is missing, you can e-mail this service card directly to the address below. However, we can only send fitting parts in this way. If you have any other cause for complaint concerning your item of furniture, please contact your furniture store directly.

**CZ** Naše přímé služby pro kování  
Chybí-li vám nějaký díl z kování, můžete tuto servisní kartu odeslat e-mailem přímo na níže uvedenou adresu. Touto cestou však můžeme rozeslat jen díly kování. Pokud byste reklamovali jiný díl nábytku, obraťte se přímo na svého prodejce nábytku.

**FR** Bien étudier la notice de montage  
S'il vous manque une ferrure, veuillez envoyer directement la présente carte service à l'adresse e-mail indiquée ci-dessous. Cependant, ceci nous permet uniquement d'envoyer des ferrures. Pour tout autre type de réclamation concernant votre meuble, veuillez contacter directement votre magasin d'ameublement.

**I** Il nostro servizio diretto per l'ordine della ferramenta  
Qualora Vi dovesse mancare un pezzo di fissaggio, allora Vi preghiamo di inviare questa carta di servizio immediatamente all'indirizzo sottostante. Possiamo inviare i pezzi di fissaggio solamente per mezzo di questo procedimento. Qualora dovete avere qualche altra reclamazione in merito al mobile, allora Vi preghiamo di rivolgerVi direttamente al Vostro Negozio di mobili.

**BG** Нашата директна услуга за обкоб  
Ако липсват части от комплекта , попълнете настоящата сервисна карта и ни я изпратете на e-mail адреса, посочен по-долу. По този начин можем да доставим само липсващи елементи от обкоба. Ако установите други дефекти по мебелите, Ви съветваме да се обърнете към мебелната къща/магазин, от който сте закупили стоката.

**NL** Onze directservice voor losse onderdelen  
Wanneer er een onderdeel ontbreekt, kunt u deze servicekaart direct aan onderstaand e-mailadres sturen. Wij kunnen langs deze weg echter alleen beslagdelen versturen. Mocht u een ander probleem aan uw meubel hebben, verzoeken wij u contact op te nemen met uw meubeldealer.

**PL** Nasz bezpośredni serwis czesci montazowych  
Jeżeli brakuje czesci koniecznych do montazu, prosimy o przeslanie nam niniejszej karty serwisowej na nizej podany adres e-mailowy. W ten sposob możemy przeslac Paístw tylko brakujace czesci. W przypadku innych reklamacji dotyczacych mebla, prosimy zglosic sié do salonu meblowego, w którym zostal dokonany zakup.

**HR** Servis za okove  
U slucaju da nedostaje neki od dijelova molimo vas da na dolje navedenu mail adresu pošaljete ovaj servisni obrazac. Na ovaj način mogu se dostaviti samo okovi. U slucaju da imate dodatne prigovore vezane uz komad namještaja molimo vas da se obratite izravno trgovini namještaja gdje je isti kupljen.

**HU** Direktszolgálatunk vasalatok esetén  
Ha hiányzik egy vasalat, ezt a kártyát közvetlenül elküldheti az alább található címre. Azonban csakis vasalatókat tudunk így küldeni. Amennyiben másfajta reklamáció áll fenn bútorárbajt illetően, forduljon közvetlenül a bútorházhöz.

**SK** Naš priamy servis pre časti kovania  
Ak by Vám chýbala nejaká časť kovania, môžete poslať túto servisnú kartu pošlou e-mailom na nižšie uvedenú adresu. Diely kovania vieme poslať iba týmto spôsobom. Ak by ste mali inú reklamáciu ohľadom Vášho nábytku, obráťte sa priamo na Vašu predajnú nábytku.

**SLO** Naše direktne uslužne storitve za okovje  
če vam manjka kakšno okovje, lahko to servisno kartico pošljete če pošli direktno na spodnji naslov. Po tej poti vam lahko pošljemo samo okovje, če želite reklamirati kakšen drug del pohištva, se obrnite neposredno na vašo trgovino pohištva.

**RO** Service-ul nostru direct pentru feronerie  
În cazul în care vă lipsese o piesă de feronerie puteţi să trimiteti direct acest card de service prin e-mail la adresa de mai jos. Noi nu putem expedia piese de feronerie decât pe această cale. Dacă aveţi o altă reclamaţie referitoare la piesa de mobilier, atunci vă rugăm să vă adresaţi direct la magazinul dvs. de mobilă.

**RU** Наш прямой сервис поставок фурнитуры  
Если окажется, что вам не хватает того или элемента фурнитуры, вы можете отправить сервисную карту по факсу непосредственно на нижеприведенный адрес электронной почты. Однако, таким образом мы можем прислать относительно приобретенной мебели, иожалуйста, обращайтесь непосредственно в организацию осуществившую продажу.

**S** Vår directservice för beslagsdelar  
Om en passande del saknas , kan du e - posta denna tjänstekort direkt till adressen nedan . Men vi kan bara skicka passande delar i den här vägen. Om du har någon annan orsak för klagomål angående ditt objekt av möbler, kontakta din möbelfärfä direkt

**ES** Nuestro servicio directo para accesorios  
Si le falta algún accesorio, puede enviar esta tarjeta de servicio directamente a la siguiente dirección. No obstante, por este método solo podemos enviar accesorios. Si tiene alguna otra objeción sobre su mueble, consulte directamente con su mueblería.

**TR** Donatılar için doğrudan servisimiz  
Nese nje pjesa e përshatshëm është zhdukur, ju mund të e -mail këtë kartë shërbimit direkt në adresën e mëposhtme. Mëqëntas, ne vetëm mund të dërgojë pjesë përshatshëm në këtë mënyrë. Nëse keni donjë shkak tjetër për ankësë në lidhje me pika juaj e mobiljeve , ju lutem kontaktoni dyqan tuaj mobilje direkt .

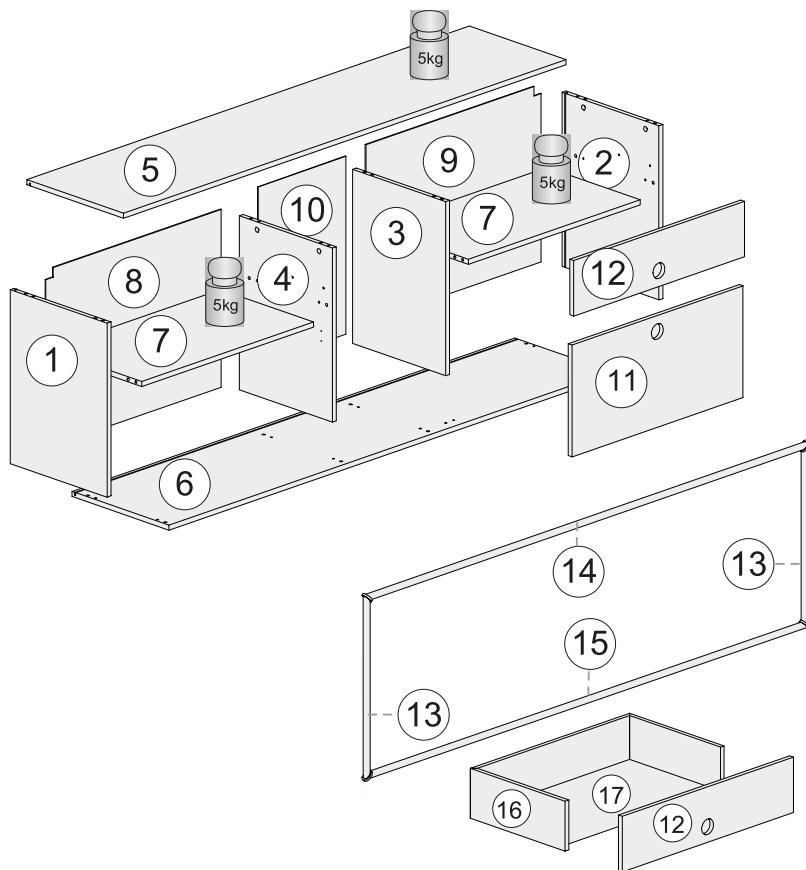

## LKZ 80181

Grund der Beanstandung / Reason of the objection:	
Möbelhaus / Furniture store:	
Name / Nom:	Telefon / Telephone:
PLZ / Bank sorting code:	Ort / City:
Strasse / Street:	
Haus-Nr. / House No.:	@E-Mail:

E-Mail Kundenservice / Customer service e-mail / E-mail servisního střediska / E-mail de notre service clientele / e-mail servizio clienti / E-mail Обслуживание на клиенту за електронна поща / E-mail klantenservice / E-mail servisu dla klientów / Servisna mail adresa / Az ügyfélszolgálat e-mail címe / E-mail zákaznického servisu / E-pošta Servisna služba / E-Mail Serviciu clienți / Обслуживание клиентов электронной почты / E-postadress kundservice

service-tt@trendteam.eu  
Hotline Trendteam:  
0049-(0)5233-9550367  
Fax: 0049-(0)52339550467

Montageanweisung / Installation instructions / Instruction de montage / Indicazioni di montaggio / номер модли / Monteringsanvisningar / Montage-instructie / Uputa za montažu / Návod k montáži / Инструкција за монтаж / Instrukcja montażu / Návod na montáž / Navodila za montažo / Instrucțiune de montaj / Инструкција по монтажу / Instrucciones de montaje / Montaj Talimatı

Modelname / Model name / Nom du modele / Model-Inamn / Nome modello / Název modelu / Modelnaam / Ime modela / Numéro Modello / Modell neve / Название модели / Názov modelu / Ime modela / Denumire model / Наименование на модела / Nazwa modelu



















# INFINITY

Modellnummer / Number / Numéro du modele / Numero modello / Номер на модлена / Ěíslo modelu / Modell száma / Eíslo modelu / Številka modela / Număr model / Broj modela / Modelnummer / Numer modelu

## 1952-707-21

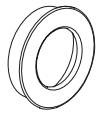
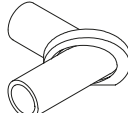
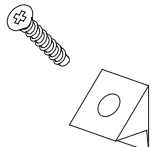
Type / Tipo / Tipus / Тип / Тип/ Tip

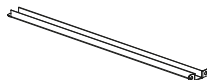
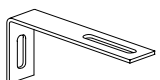
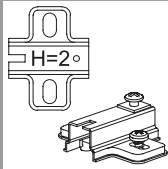
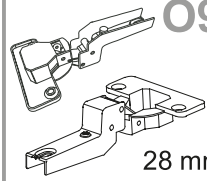
# 707

<b>A</b>  Ø15x13mm <b>n.16</b>	<b>A2</b>  Ø15x10mm <b>n.2</b>	<b>B</b>  <b>n.18</b>	<b>C</b>  Ø8x30mm <b>n.24</b>	<b>D</b>  Ø6x11mm <b>n.4</b>	<b>F</b>  Ø5x50mm <b>n.8</b>
<b>F3</b>  Ø3x12mm <b>n.3</b>	<b>F5</b>  Ø3,5x16mm <b>n.16</b>	<b>F6</b>  Ø4x30mm <b>n.6</b>	<b>F7</b>  Ø3,5x25mm <b>n.6</b>	<b>F24</b>  Ø4x16mm <b>n.2</b>	<b>F39</b>  Ø2,5x12mm <b>n.8</b>
<b>G2</b>  <b>n.6</b>	<b>L2</b>  Ø20 <b>n.20</b>	<b>L7</b>  Ø10 <b>n.4</b>	<b>L10</b>  <b>n.2</b>	<b>L11</b>  <b>n.4</b>	<b>M</b>  <b>n.26</b>
<b>M1</b>  <b>n.6</b>	<b>M7</b>  <b>n.1</b>	<b>N</b>  <b>n.2</b>	<b>O</b>  <b>n.2</b>	<b>O9</b>  28 mm <b>n.2</b>	<b>Z</b>  <b>n.1</b>

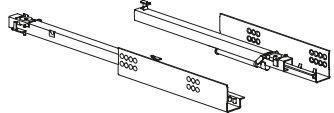
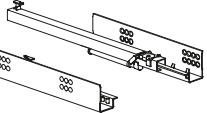
<b>E7a</b>  350mm	<b>E7b</b> 	<b>E7</b> <b>n.1+1</b>
---	---	---------------------------

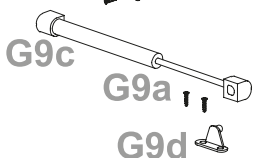
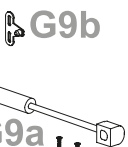
<b>G9a</b> 	<b>G9b</b> 	<b>G9</b> <b>n.1</b>
---	---	-------------------------

Nr.	Maße (mm)	Colli	Anzahl
1	542x400x16	2/2	1
2	542x400x16	2/2	1
3	542x385x16	2/3	1
4	542x385x16	2/2	1
5	1829x400x16	1/2	1
6	1829x400x16	1/2	1
7	710x385x16	2/2	1
8-9	556x725x16	1/2	2
10	556x359x 3	1/2	1
11	708x349x16	2/2	1
12	708x173x16	1/2	1
13	575x 20x 1	1/2	2
14	1828x20x 1	1/2	1
15	1828x20x 1	1/2	1
16	692x350x115	1/2	1
17	679x350x 3	1/2	1

