

LKZ 80106

Modellname/Modelname/Nomdumodele/Modellnamn
Nomemodello/Názevmodelu/Modelnaam/Imemodella
NuméroModello/Modellneve/ Названиемодели /
Názovmodelu/Imemodella/Denumiremodel/
Наименованиемодели /Nazwamodelu

**GWENDOLYN
ROCK**

Modellnummer/Number/Numérodumodele
Numero/ Номернамодели/modello
Číslomodelu/Modellszáma/Eíslomodelu
Števílkamodella/ Numărmodel /Brojmodella
Modelnummer/Numermamodelu

1826-862-01
1826-862-35
1826-862-48
1826-862-49

Type / Tipo / Tipus / Тур / Тип / Tip

862

D

Unser Direktservice für Beschlagteile

Sollte Ihnen ein Beschlagteil fehlen, können Sie diese Servicekarte direkt an die untenstehende Adresse mailen. Wir können allerdings nur Beschlagteile auf diesem Wege verschicken. Sollten Sie eine andere Beanstandung an Ihrem Möbelstück haben, so wenden sie sich bitte direkt an Ihr Möbelhaus.

Our direct order service for fitting

If a fitting part is missing, you can e-mail this service card directly to the address below. However, we can only send fitting parts in this way. If you have any other cause for complaint concerning your item of furniture, please contact your furniture store directly.

Naše přímé služby pro kování

Chybí-li vám nějaký díl z kování, můžete tuto servisní kartu odeslat e-mailem přímo na níže uvedenou adresu. Touto cestou však můžeme zoslat jen díly kování. Pokud byste reklamovali jiný díl nábytku, obraťte se přímo na svého prodejce nábytku.

Bien etudier la notice de montage

S'il vous manque une ferrure, veuillez envoyer directement la présente carte service à l'adresse e-mail indiquée ci-dessous. Cependant, ceci nous permet uniquement d'envoyer des ferrures. Pour tout autre type de réclamation concernant votre meuble, veuillez contacter directement votre magasin d'ameublement.

Il nostro servizio diretto per l'ordine della ferramenta

Qualora Vi dovesse mancare un pezzo di fissaggio, allora Vi preghiamo di inviare questa carta di servizio immediatamente all'indirizzo sottostante. Possiamo inviare i pezzi di fissaggio solamente per mezzo di questo procedimento. Qualora dovete avere qualche altra reclamazione in merito al mobile, allora Vi preghiamo di rivolgerVi direttamente al Vostro Negozio di mobili.

Нашата директна услуга за обков

Ако липсват части от комплекта, попълнете настоящата сервисна карта и ни я изпратете на e-mail адреса, посочен по-долу. По този начин можем да доставим само липсващи елементи от обкова. Ако установите други дефекти по мебелите, Ви съветваме да се обърнете към мебелната къща/магазин, от който сте закупили стоката.

GB

CZ

F

I

BG

NL

PL

HR

HU

SK

SLO

RO

RUS

S

ES

TR

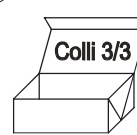
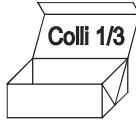
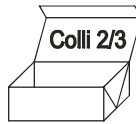
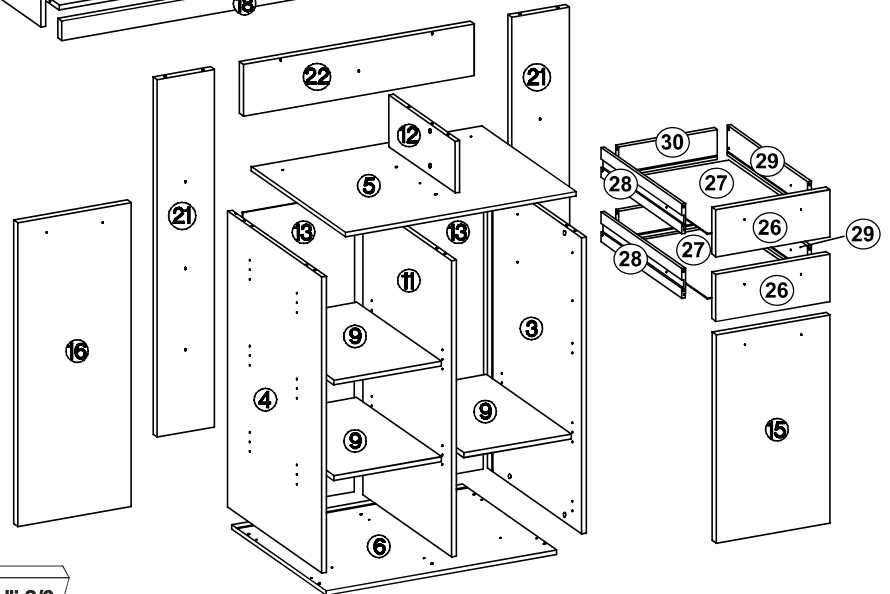
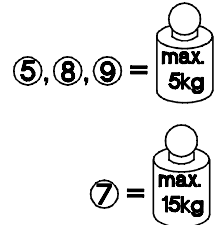
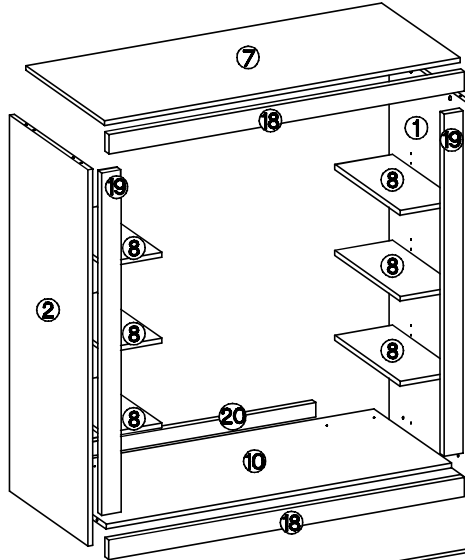

Grund der Beanstandung / Cause for complaint:

Möbelhaus / Furniture store:

Kunde / Customer:

Telefon / Telephone:

PLZ / Postcode:

Ort / City:

Str.+Nr. / Street address

@E-Mail:

E-Mail Kundenservice / Customer service e-mail / E-mail servisního střediska / E-mail de notre service clientèle / e-mail servizio clienti / E-mail от отдела за обслужване на клиенти / E-mail klantenservice / E-mail servisu dla klientów / Servisna mail adresa / Az ügyfélszolgálat e-mail címe / E-mail zákaznického servisu / E-pošta Servisna služba / E-mail Serviciu clienți / Servicio de atención por correo electrónico / Müşteri hizmetleri e-postası

service-tt@trendteam.eu
Hotline: +49 5233 955 0367
Fax: +49 5233 955 0467

LKZ 80106

Modellname/Modelname/Nomdumodele/Modellnamn
Nomemodello/Názevmodelu/Modelnaam/Imemodela
NúmeroModello/Modellneve/ Названиемодели /
Názovmodelu/Imemodela/Denumiremodel/
Наименованиемодела /Nazwamodelu

**GWENDOLYN
ROCK**

















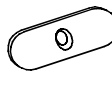







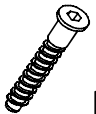

Modellnummer/Number/Numérodumodele
Numero/ Номернамодела/modello
Číslomodelu/Modellszáma/Eislomodelu
Številkamodela/ Numãrmodel /Brojmodela
Modelnummer/Numermodelu

1826-862-01
1826-862-35
1826-862-48
1826-862-49

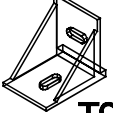
Type / Tipo / Típus / Тур / Тип / Tip

862

B1 Colli 1/3

 I4 2	 E 6	 E13 8	 U1 4	 T3 5	 P7 6	 L2 6	 O1 1		
 H 4	 G 4	 P5 9	 B2 4	 D2 32	 C 32	 A 36	 E 8	 M2 8	
 B 1	 O 1	 S17 4	 R1 8						
 P1 42	 T9 16	 O7 1	 L9 1						
 F4 10	 J3 36	 R2 4	 L 10						

