

LKZ 80106

Modelname / Model name / Nom du modèle / Modellname
Nome modello / Název modelu / Modelnaam / Ime modela
Número Modelo / Modell neve / Наименование модели /
Názov modelu / Ime modela / Denimbre model /
Наименование на модела / Nazwa modelu

GWENDOLYN / ROCK

Modelnummer / Number / Numéro du modèle
Numero / Hower na modeli / modello
Číslo modelu / Modell száma / Értelmező
Številka modela / Numár model / Broj modela
Modelnummer / Numer modelu

1826-878-01
1826-878-35
1826-878-48
1826-878-49

Type / Tipo / Tipus / Typ / Тип / Tip

878

D

Unser Direktservice für Beschädigte

Sollte Ihnen ein Beschädigte fehlen, können Sie diese Servicekarte direkt an die untenstehende Adresse mailen. Wir können allerdings nur Beschädigte auf diesem Wege verschicken. Sollten Sie eine andere Beanstandung an Ihrem Möbelstück haben, so wenden Sie sich bitte direkt an Ihr Möbelhaus.

GB

Our direct order service for fitting

If a fitting part is missing, you can e-mail this service card directly to the address below. However, we can only send fitting parts in this way. If you have any other cause for complaint concerning your item of furniture, please contact your furniture store directly.

CZ

Naše přímé služby pro kování

Chybí vám nějaký díl z kování, můžete tuto servisní kartu odeslat e-mailem přímo na níže uvedenou adresu. Touto cestou však můžeme zosadit jen díly kování. Pokud byste reklamovali jiný díl nábytku, obraťte se přímo na svého prodejce nábytku.

F

Bien étudier la notice de montage

Si l'un vous manque une ferrure, veuillez envoyer directement la présente carte service à l'adresse e-mail indiquée ci-dessous. Cependant, ceid nous permet uniquement d'envoyer des ferrures. Pour tout autre type de réclamation concernant votre meuble, veuillez contacter directement votre magasin d'ameublement.

I

Il nostro servizio diretto per l'ordine della ferramenta

Qualora Vi dovesse mancare un pezzo di fissaggio, allora Vi preghiamo di inviare questa carta di servizio immediatamente all'indirizzo sottostante. Possiamo inviare i pezzi di fissaggio solamente per mezzo di questo procedimento. Qualora dovesse avere qualche altra reclamazione in merito al mobile, allora Vi preghiamo di rivolgerVi direttamente al Vostro Negozio di mobili.

BG

Нашата директна услуга за обкоя

Ako липсват части от комплекта, попълнете настоящата сервисна карта и ни я изпратете на e-mail адреса, посочен по-долу. По този начин можем да доставим само липсващи елементи от обкоя. Ако установите други дефекти по мебелите, Ви съветваме, да се обърнете към мебелната къща/магазин, от който сте закупили стоката.

NL

Onze directservice voor losse onderdelen

Wanneer er een onderdeel ontbreekt, kunt u deze servicekaart direct aan onderstaand e-mailadres sturen. Wij kunnen lange deze weg echter alleen beschadigen versturen. Mocht u een ander probleem aan uw meubel hebben, verzoeken wij u contact op te nemen met uw meubeldealer.

PL

Nasz bezpośredni serwis części montażowych

Jeżeli brakuje części końcowych do montażu, prosimy o przesłanie nam niniejszej karty serwisowej na niżej podany adres e-mailowy. W ten sposób możemy przysłać Państwu tylko brakujące części. W przypadku innych reklamacji dotyczących mebla, prosimy zgłosić się do salonu meblowego, w którym został dokonany zakup.

HR

Service za okove

U slučaju da nedostaje neki od dijelova molimo vas da na dole navedenu mail adresu pošaljete ovaj servisni obrazac. Na ovaj način mogu se dostaviti samo okovi. U slučaju da imate dodatne prigovore vezane uz komad namještaja molimo vas da se obratite izravno trgovini namještaja gdje je isti kupljen.

HU

Direktszolgálatunk vasalatok esetén

Ha hiányzik egy vasalat, ezt a kártyát közvetlenül elküldheti az alább található címre. Azonban csak a vasalokat tudunk így küldeni. Amennyiben másfajta reklamációt áll fenn bitorárbajt illetően, forduljon közvetlenül a bitorházhoz.

SK

Náš priamy servis pre ďalšie kovania

Ak by Vám chýbala nejaká časť kovania, môžete poslať túto servisnú kartu pošťou e-mailom na nižšie uvedené adresu. Diely kovania vieme poslať iba týmto spôsobom. Ak by ste mali inú reklamáciu ohľadom Vášho nábytku, obráťte sa priamo na Vašu predajňu nábytku.

SLO

Naše direktno uslužne storitve za okovje

Če vam manjka kakšno okovje, lahko to servisno kartico pošljete po e-pošti direktno na spodnji naslov. Po tej poti vam lahko pošljemo samo okovje. Če želite reklamirati kakšen drug del pohištva, se obrnite neposredno na vašo trgovino pohištva.

RO

Service-ul nostru direct pentru feronerie

În cazul în care vă lipsesc o piesă de feronerie puteţi sa trimiteţi direct acest card de service prin e-mail la adresa de mai jos. Noi nu putem expedia piese de feronerie decât pe această cale. Dacă aveţi o altă reclamaţie referitoare la piesa de mobilier, atunci vă rugăm să vă adresaţi direct la magazinul dvs. de mobilier.

RUS

Наш прямой сервис для поставки фурнитуры

Если окажется, что Вам не хватает того или иного элемента фурнитуры, Вы можете отправить сервисную карту по факсу непосредственно на нижеприведенный адрес электронной почты. Однако, таким образом мы можем переслать лишь фурнитуру. Если же у Вас возникнут иные претензии относительно приобретенной мебели, пожалуйста, обращайтесь непосредственно в организацию, осуществившую продажу.

S

Vår direktservice för beslagdelar

Om du saknar en beslagdel kan du skicka detta servicekort direkt till e-postadressen som anges nedan. Tank på att detta är den enda möjligheten att skicka beslagdelar till dig. Om du vill reklamera din möbel av en annan anledning måste du kontakta ditt möbelhus direkt.

ES

Nuestro servicio directo para accesorios

Si le falta algún accesorio, puede enviar esta tarjeta de servicio directamente a la siguiente dirección. No obstante, por este método solo podemos enviar accesorios. Si tiene alguna otra objeción sobre su mueble, consulte directamente con su mueblería.

TR

Donatılar için doğrudan servisimiz

Bir donatı iz eksikse bu servis kartını doğrudan aşağıda bulunan adrese doğrudan mail yazabilirsiniz. Sadece bu yolla donatılar gönderilir. Mobilyanızda başka şikayetleriniz varsa lütfen doğrudan mobilya satıcınıza danışın.



= 8, 9, 10

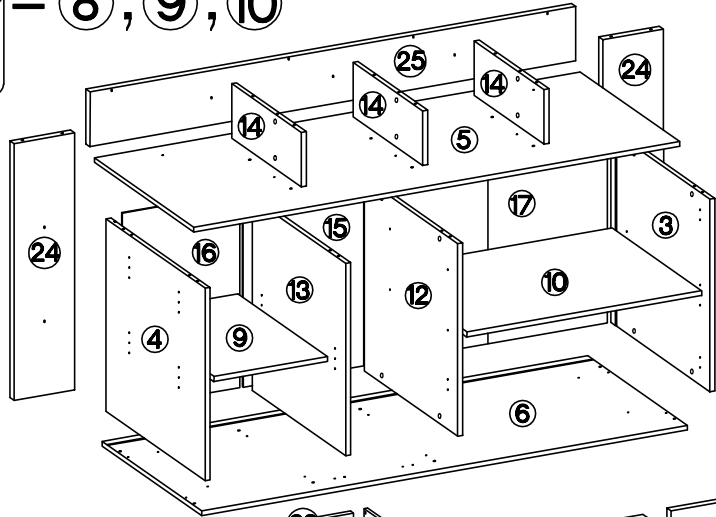

= 7

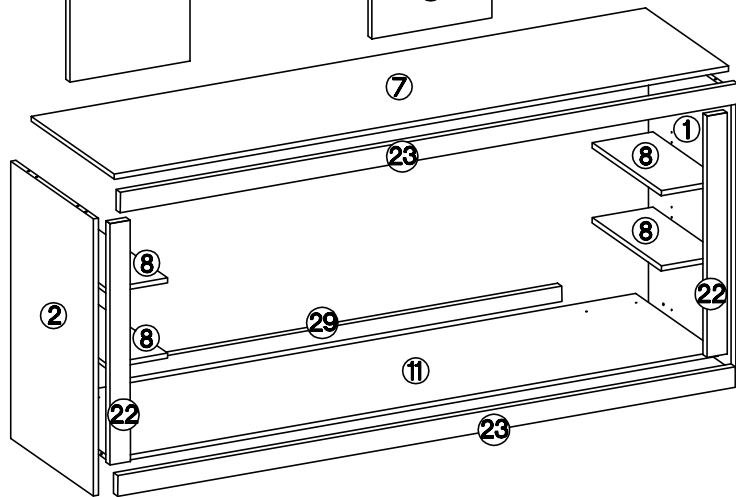
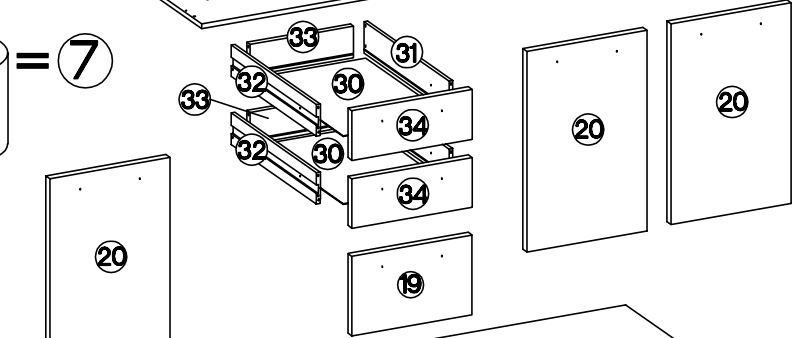

Grund der Beanstandung / Cause for complaint:

Möbelhaus / Furniture store:

Kunde / Customer:

Telefon / Telephone:

PLZ / Postcode:

Ort / City:

Str. + Nr / Street address:

@E-Mail:

LKZ 80106

Modellname / Model name / Nom du modèle / Modellnamn
Nome modello / Název modelu / Modelnaam / Ime modela
Número Modelo / Modell neve / Наименование модели /
Názov modelu / Ime modela / Denumire model /
Наименование на модела / Nazwa modelu

GWENDOLYN / ROCK

Modelnummer / Number / Numéro du modèle
Número / Номер на модели / modello
Číslo modelu / Modell száma / Ételő modelje
Številka modela / Număr model / Broj modela
Modelnummer / Numer modelu











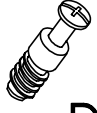

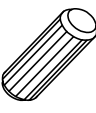

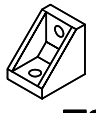

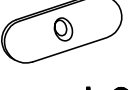





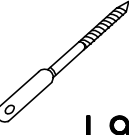



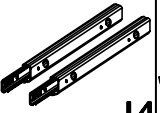

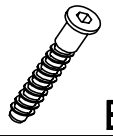
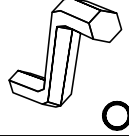

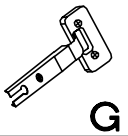
1826-878-01
1826-878-35
1826-878-48
1826-878-49

Type / Tipo / Tipus / Typ / Тип / Tip

878

Nr.	Abmessung (mm)			Anzahl	Colli
1.	880	320	16	x1	3/3
2.	880	320	16	x1	3/3
3.	611	384	16	x1	2/3
4.	611	384	16	x1	2/3
5.	1566	385	16	x1	2/3
6.	1566	385	16	x1	2/3
7.	1991	321	16	x1	3/3
8.	196	268	16	x4	3/3
9.	366	347	16	x1	2/3
10.	757	347	16	x1	2/3
11.	1957	319	16	x1	3/3
12.	611	362	16	x1	1/3
13.	611	362	16	x1	1/3
14.	173	270	16	x3	2/3
15.	620	389	2,5	x1	1/3
16.	620	379	2,5	x1	1/3
17.	620	770	2,5	x1	1/3
19.	387	253	16	x1	1/3
20.	637	387	16	x3	1/3
22.	767	65	16	x2	3/3
23.	1991	65	16	x2	3/3
24.	816	195	16	x2	1/3
25.	173	1566	16	x1	2/3
29.	1415	48	16	x1	2/3
30.	326	352	2,5	x2	1/3
31.	330	100	12	x2	3/3
32.	330	100	12	x2	3/3
33.	342	100	12	x2	3/3
34.	387	189	16	x2	1/3
B1				x1	

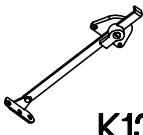
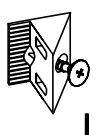
B1

		L=20mm	±15/12mm	±8x30mm	
		 D2	 C	 A	 E
		44	40	44	12
 T3	±3.0x16mm  P11	 L2	 O1	±4.0x27mm  R1	±4.0x16mm  P1
5	13	10	1	12	46
 T9	±10x50mm  O7	 L9	±15x5mm  F4	±5/16mm  J3	±4.0x30mm  R2
18	2	2	10	24	4
 I4	L=192mm  S17	6,4 x 50mm  B	 O	 H	±35/0mm  G
2	6	3	1	6	6
±3.5x13mm  P5	±6x42mm  B2	±6,3x13mm  M2	M4x9mm  U1	H=2  H4	±35/9mm  G1
22	4	8	4	2	2
 E	 K13	 L	±14  E13	±12/10mm  C5	
10	1	12	8	4	

