

LKZ: 80596

Modellname/Modelname/Nomdumodele/Modellnamn  
Nomemodello/Názvumodelu/Modelnaam/Imemodela  
NúmeroModello/Modelneve/ Названиемодели /  
Názovmodelu/Imemodela/Denumiremodel/  
Наименованиемоделя /Nazwamodelu

**OLIVIA/JULIE**

Modellnummer/Number/Numérodumodele  
Numero/ Номернамоделя/modello  
Číslomodelu/Modellszáma/Eíslomodelu  
Številkamodela/ Numärmodel /Brojmodela  
Modelnummer/Numemodellu

**1553-613-01**

Type/Tipo/Típus/Typ/Тип /Tip

**613**

**D** **Unser Direktservice für Beschlaeteile**  
Sollte Ihnen ein Beschlagteil fehlen, können Sie diese Servicekarte direkt an die untenstehende Adresse mailen. Wir können allerdings nur Beschlagteile auf diesem Wege verschicken. Sollten Sie eine andere Beanstandung an Ihrem Möbelstück haben, so wenden Sie sich bitte direkt an Ihr Möbelhaus.

**GB** **Our direct order service for fitting**  
If a fitting part is missing, you can e-mail this service card directly to the address below. However, we can only send fitting parts in this way. If you have any other cause for complaint concerning your item of furniture, please contact your furniture store directly.

**CZ** **Naše přímé služby pro kování**  
Chybí-li vám nějaký díl z kování, můžete tuto servisní kartu odeslat e-mailem přímo na níže uvedenou adresu. Touto cestou však můžeme zadeslat jen díly kování. Pokud byste reklamovali jiný díl nábytku, obraťte se přímo na svého prodejce nábytku.

**F** **Bien étudier la notice de montage**  
S'il vous manque une ferrure, veuillez envoyer directement la présente carte service à l'adresse e-mail indiquée ci-dessous. Cependant, ceci nous permet uniquement d'envoyer des ferrures. Pour tout autre type de réclamation concernant votre meuble, veuillez contacter directement votre magasin d'ameublement.

**I** **Il nostro servizio diretto per l'ordine della ferramenta**  
Qualora Vi dovesse mancare un pezzo di fissaggio, allora Vi preghiamo di inviare questa carta di servizio immediatamente all'indirizzo sottostante. Possiamo inviare i pezzi di fissaggio solamente per mezzo di questo procedimento. Qualora doveste avere qualche altra reclamazione in merito al mobile, allora Vi preghiamo di rivolgerVi direttamente al Vostro Negozio di mobili.

**BG** **Нашата директна услуга за обков**  
Ако липсват части от комплекта, потърнете настоящата сервисна карта и ни я изпратете на e-mail адреса, посочен по-долу. По този начин можем да доставим само липсващи елементи от обкова. Ако установите други дефекти по мебелите, Ви съветваме да се обърнете към мебелната къща/магазин, от който сте закупили стоката.

**NL** **Onze directservice voor losse onderdelen**  
Wanneer er een onderdeel ontbreekt, kunt u deze servicekaart direct aan onderstaand e-mailadres sturen. Wij kunnen langs deze weg echter alleen beslagdelen versturen. Mocht u een ander probleem aan uw meubel hebben, verzoeken wij u contact op te nemen met uw meubeldealer.

**PL** **Nasz bezpośredni serwis części montażowych**  
Jeżeli brakuje części koniecznych do montażu, prosimy o przesłanie nam niniejszej karty serwisowej na niżej podany adres e-mailowy. W ten sposób możemy przelać Państwu tylko brakujące części. W przypadku innych reklamacji dotyczących mebli, prosimy zgłosić się do salonu meblowego, w którym został dokonany zakup.

**HR** **Servis za okove**  
U slučaju da nedostaje neki od dijelova molimo vas da na dolje navedenu mail adresu pošaljete ovaj servisni obrazac. Na ovaj način mogu se dostaviti samo okovi. U slučaju da imate dodatne prigovore vezane uz komad namještaja molimo vas da se obratite izravno trgovini namještaja gdje je isti kupljen.

**HU** **Direktszolgáltatunk vasalatok esetén**  
Ha hiányzik egy vasalat, ezt a kártyát közvetlenül elküldheti az alább található címre. Azonban csakis vasalatokat tudunk így küldeni. Amennyiben másfajta reklamációt áll fenn bútordarabját illetően, forduljon közvetlenül a bútórháznak.

**SK** **Náš priamy servis pre časti kovania**  
Ak by Vám chýbala nejaká časť kovania, môžete poslať túto servisnú kartu pošťou e-mailom na nižšie uvedenú adresu. Díly kovania vieme poslať iba týmto spôsobom. Ak by ste mali inú reklamáciu ohľadom Vášho nábytku, obráťte sa priamo na Vašu predajnú nábytku.

**SLO** **Naše direktno servisne storitve za okovje**  
Če vam manjka kakšno okovje, lahko to servisno kartico pošljete po e-pošti direktno na spodnji naslov. Po tej poti vam lahko pošljemo samo okovje. Če želite reklamirati kakšen drug del pohištva, se obrnite neposredno na vašo trgovino pohištva.

**RO** **Service-ul nostru direct pentru feronerie**  
În cazul în care vă lipsește o piesă de feronerie puteți să trimiteți direct acest card de service prin e-mail la adresa de mai jos. Noi nu putem expedia piese de feronerie decât pe această cale. Dacă aveți o altă reclamație referitoare la piesa de mobilier, atunci vă rugăm să vă adresați direct la magazinul dvs. de mobilier.

**RUS** **Наш прямой сервис для поставок фурнитуры**  
Если ожидается, что Вам не хватает того или иного элемента фурнитуры, Вы можете отправить сервисную карту по факсу непосредственно на нижеприведенный адрес электронной почты. Однако, таким образом мы можем пересылать лишь фурнитуру. Если же у Вас возникнут иные претензии относительно приобретенной мебели, пожалуйста, обращайтесь непосредственно в организацию, осуществившую продажу.

**S** **Vår direktservice för beslagdelar**  
Om du saknar en beslagdel kan du skicka detta servicekort direkt till e-postadressen som anges nedan. Tank på att detta är den enda möjligheten att skicka beslagdelar till dig. Om du vill reklamera din möbel av en annan anledning måste du kontakta ditt möbelhus direkt.

**ES** **Nuestro servicio directo para accesorios**  
Si le falta algún accesorio, puede enviar esta tarjeta de servicio directamente a la siguiente dirección. No obstante, por este método solo podemos enviar accesorios. Si tiene alguna otra objeción sobre su mueble, consulte directamente con su mueblería.

**TR** **Donatılar için doğrudan servisimiz**  
Bir donatıhız eksikse bu servis kartını doğrudan aşağıdaki bulunan adrese doğrudan mail yazabilirsiniz. Sadece bu yolla donatılar gönderebiliriz. Mobilyanızda başka şikayetleriniz varsa lütfen doğrudan mobilya satıcınıza danışın.

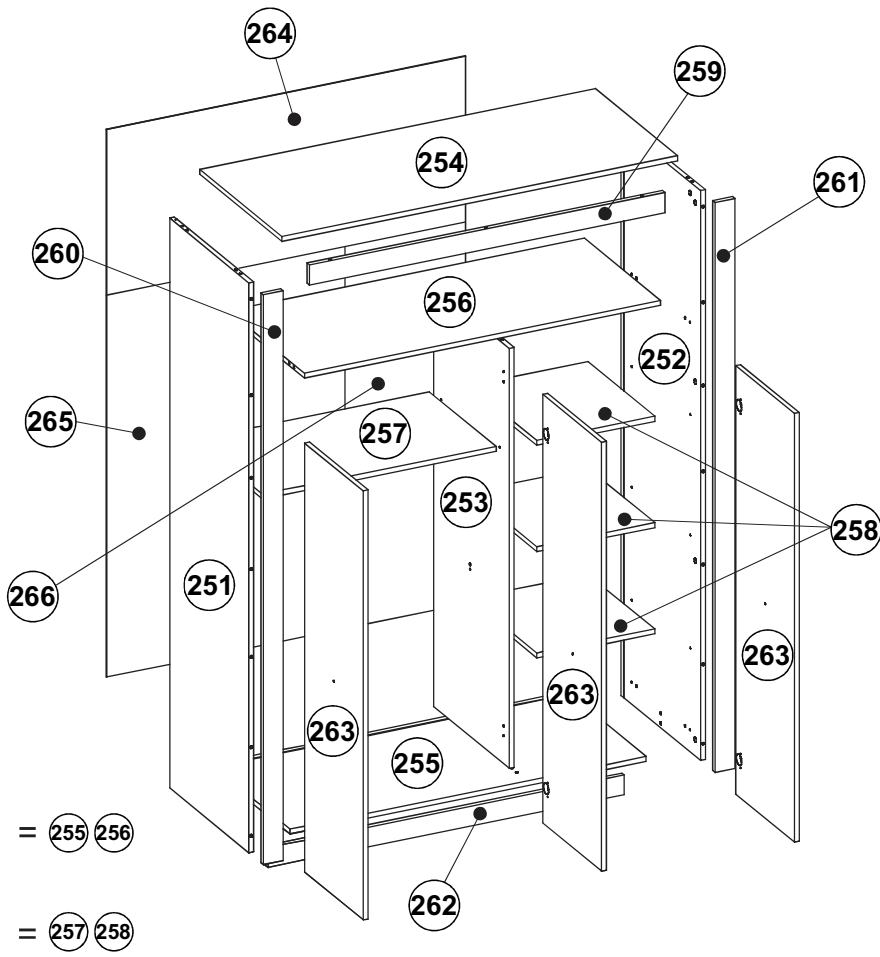

A	B (mm)		C	D
251	1835	522	16	x1 2/3
252	1835	522	16	x1 2/3
253	1353	500	16	x1 1/3
254	1301	540	16	x1 1/3
256	1267	500	16	x1 1/3
255	1267	522	16	x1 1/3
260	1835	65	16	x1 2/3
261	1835	65	16	x1 2/3

A	B (mm)		C	D
259	1169	65	16	x1 1/3
262	1267	63	16	x1 1/3
264	1279	400	2.5	x1 3/3
265	1366	832	2.5	x1 3/3
266	1366	445	2.5	x1 3/3
257	819	486	16	x1 1/3
258	432	486	16	x3 2/3
263	1381	386	16	x3 3/3
B171				

Grund der Beanstandung / Reason of the objection:

---

Möbelhaus / Furniture store:

Name / Name: \_\_\_\_\_ Telefon / Telephone: \_\_\_\_\_

PLZ / postal code: \_\_\_\_\_ Ort / City: \_\_\_\_\_

Strasse / Street: \_\_\_\_\_

Haus-Nr. / House No.: \_\_\_\_\_ @E-Mail: \_\_\_\_\_

LKZ: 80596

Modellname/Modelname/Nomdumodele/Modellnamn  
Nomemodello/Názevmodelu/Modelnaam/Imemodela  
NuméroModello/Modellneve/ Названиемодели /  
Názovmodelu/Imemodela/Denumiremodel/  
Наименованиенамодела /Nazwamodelu

**OLIVIA/JULIE**











Modellnummer/Number/Numérodumodele  
Numero/ Номернамодела/modello  
Číslo modelu/Modellszáma/Eíslomodelu  
Številka modela/ Numărmodel /Brojmodela  
Modelnummer/Numemodulu







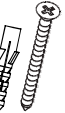



**1553-613-01**



Type/Tipo/Típus/Typ/Тип /Tip

**613**

## B171 (COLLI 1/3)

<b>A2</b>  ø8x35 <b>x26</b>	<b>B1</b>  ø7x50 <b>x2</b>	<b>C0</b>  <b>x25</b>	<b>C2</b>  <b>x25</b>	<b>C7</b>  16mm <b>x25</b>	<b>D0</b>  3,5x15 <b>x22</b>	<b>D16</b>  4,2x30 <b>x3</b>	<b>D25</b>  3x16 <b>x16</b>	<b>E0</b>  10x50 <b>x1</b>	<b>J5</b>  <b>x2</b>
----------------------------------------------------------------------------------------------------------------------	----------------------------------------------------------------------------------------------------------------------	--------------------------------------------------------------------------------------------------------------	--------------------------------------------------------------------------------------------------------------	----------------------------------------------------------------------------------------------------------------------	------------------------------------------------------------------------------------------------------------------------	------------------------------------------------------------------------------------------------------------------------	-----------------------------------------------------------------------------------------------------------------------	------------------------------------------------------------------------------------------------------------------------	---------------------------------------------------------------------------------------------------------------

<b>J6</b>  <b>x2</b>	<b>J26</b>  <b>x4</b>	<b>J27</b>  H=4 <b>x4</b>	<b>K</b>  4mm <b>x1</b>	<b>L31</b>  <b>x3</b>	<b>M1</b>  <b>x12</b>	<b>M3</b>  <b>x16</b>	<b>O6</b>  <b>x4</b>	<b>P0</b>  <b>x1</b>	<b>P29</b>  <b>x2</b>
--------------------------------------------------------------------------------------------------------------	----------------------------------------------------------------------------------------------------------------	-----------------------------------------------------------------------------------------------------------------------	---------------------------------------------------------------------------------------------------------------------	----------------------------------------------------------------------------------------------------------------	----------------------------------------------------------------------------------------------------------------	----------------------------------------------------------------------------------------------------------------	---------------------------------------------------------------------------------------------------------------	-----------------------------------------------------------------------------------------------------------------	------------------------------------------------------------------------------------------------------------------

<b>Q0</b>  <b>x16</b>	<b>S0</b>  L-814 <b>x2</b>	<b>T3</b>  <b>x5</b>
---------------------------------------------------------------------------------------------------------------	------------------------------------------------------------------------------------------------------------------------	---------------------------------------------------------------------------------------------------------------

