

LKZ-80677

Modellname / Model name / Nom du modele / Modellnamn / Nome modello / Název modelu / Modelnaam / Ime modela / Numéro Modelo / Modell neve / Название модели / Názov modelu / Ime modela / Denumire model / Наименование на модела / Nazwa modelu

INDY

Modellnummer / Number / Numéro du modele / Numero / Номер на модела / Modello / Número Modelo / Modell száma / Eíslo modelu / Številka modela / Număr model / Broj modela / Modelnummer / Numer modelu

1879-127-23

Type / Tipo / Típus / Typ / Тип / Tip

127

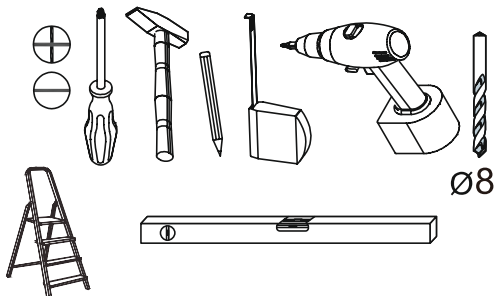
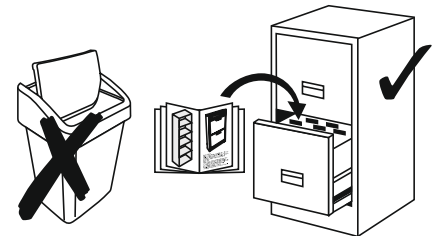
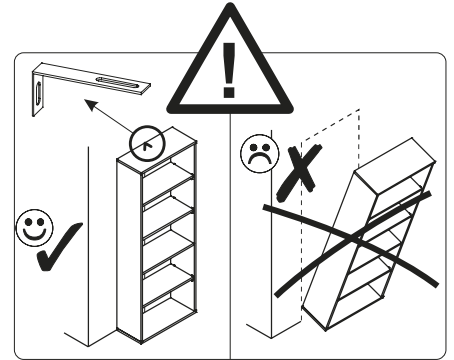
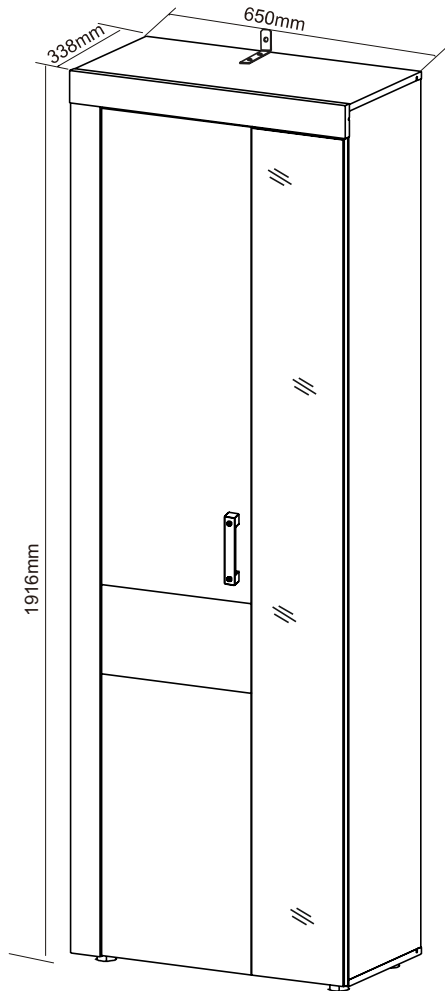
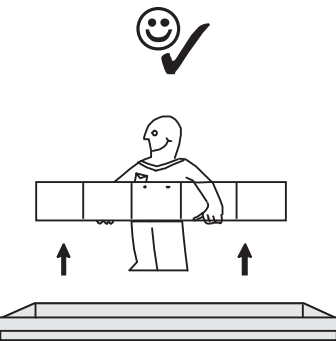
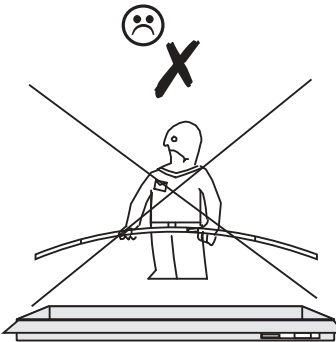
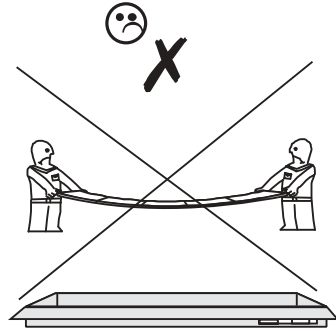
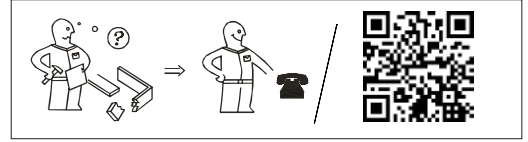
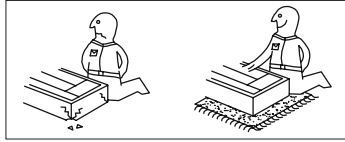
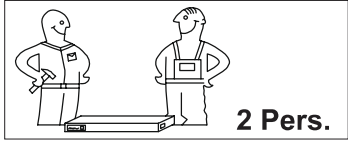

festziehen / tighten / Затягнете / serrer / stringere / utáhnout / vasttrekken / zategnuti / strângere / zwiázac / zacisnac / szorosan meghúzni / pevne dotiahnut / trdno pritegniti / затянуть / dra át

eindrücken / press in / enfoncer / wcisnac / ribattere / zatláèit / Вєараòе / indrukken / benyomni / stlacit' / vtisniti / tryck in / introducere prin apásare / вдавить

ausmessen / measure / mesurer / misurare / opmeten / izmeriti / miara / kimérni / izmeriti / mäsurare / измерить / zmèit / Èçepeòe / mät upp / zmierzyc



drücken / press / presser / stisknout / Натиснете / vtisniti / nasinac / drukkan / pritisnuti / nacinac / pritisniti / нажать / (meg)nyomni / zapasare / tryck fast / nacinac

einschlagen / hammer in / bevèrni / sla in / frapper au marteau / infossare / Zabit' / zarazit / Набийте / zabiti / wbic / introducere prin bãtaie / забить / zatlouct

Drehen - wenden /przekreçic -odwróciç / Keren - omdraaien / Girare - Ruotare / Okrenuti - ubrnuti / Retourner - renverser / Turn over - turn around / Ocloce - obratte / Завърте - обърнете / Obrnite list / прокрутит - повернуть / otoèit - obrátit / elforgatni - megfordítani

LKZ-80677

Modellname / Model name / Nom du modele / Modellnamn
Nome modello / Název modelu / Modelnaam / Ime modela
Número Modelo /Modell neve / Название модели/
Názov modelu / Ime modela / Denumire model /
Наименование на модела / Nazwa modelu

INDY

Modellnummer / Number / Numéro du modele
Numero / Номер на модела / Modello
Èislo modelu / Modell száma / Eíslo modelu
Številka modela / Număr model / Broj modela
Modelnummer / Numer modelu

1879-127-23

Type / Tipo / Típus / Typ / Тип / Tip

127

D Unser Direktservice für Beschlagteile
Sollte Ihnen ein Beschlagteil fehlen, können Sie diese Servicekarte direkt an die untenstehende Adresse mailen. Wir können allerdings nur Beschlagteile auf diesem Wege verschicken. Sollten Sie eine andere Beanstandung an Ihrem Möbelstück haben, so wenden sie sich bitte direkt an Ihr Möbelhaus.

GB Our direct order service for fitting
If a fitting part is missing, you can e-mail this service card directly to the address below. However, we can only send fitting parts in this way. If you have any other cause for complaint concerning your item of furniture, please contact your furniture store directly.

CZ Naše přímé služby pro kování
Chybí-li vám nějaký díl z kování, můžete tuto servisní kartu odeslat e-mailem přímo na ní uvedenou adresu. Touto cestou však můžeme rozesílat jen díly kování. Pokud byste reklamovali jiný díl nábytku, obraťte se přímo na svého prodejce nábytku.

F Bien etudier la notice de montage
S'il vous manque une ferrure, veuillez envoyer directement la présente carte service à l'adresse e-mail indiquée ci-dessous. Cependant, ceci nous permet uniquement d'envoyer des ferrures. Pour tout autre type de réclamation concernant votre meuble, veuillez contacter directement votre magasin d'ameublement.

I Il nostro servizio diretto per l'ordine della ferramenta
Qualora Vi dovesse mancare un pezzo di fissaggio, allora Vi preghiamo di inviare questa carta di servizio immediatamente all'indirizzo sottostante. Possiamo inviare i pezzi di fissaggio solamente per mezzo di questo procedimento. Qualora dovete avere qualche altra reclamazione in merito al mobile, allora Vi preghiamo di rivolgerci direttamente al Vostro Negozio di mobili.

BG Нашата директна услуга за обков
Ако липсват части от комплекта, попълнете настоящата сервисна карта и ни я изпратете на e-mail адреса, посочен по-долу. По този начин можем да доставяме само липсващи елементи от обкова. Ако установите други дефекти по мебелите, Ви съветваме да се обърнете към мебелната къща/магазин, от който сте закупили стоката.

NL Onze directservice voor losse onderdelen
Wanneer er een onderdeel ontbreekt, kunt u deze servicekaart direct aan onderstaand e-mailadres sturen. Wij kunnen langs deze weg echter alleen beslagdelen versturen. Mocht u een ander probleem aan uw meubel hebben, verzoeken wij u contact op te nemen met uw meubeldealer.

PL Nasz bezpośredni serwis części montażowych
Jeżeli brakuje części końcowych do montażu, prosimy o przesłanie nam niniejszej karty serwisowej na niżej podany adres e-mailowy. W ten sposób możemy przysłać Państwu tylko brakujące części. W przypadku innych reklamacji dotyczących mebla, prosimy zgłosić się do salonu meblowego, w którym został dokonany zakup.

HR Servis za okove
U slučaju da nedostaje neki od dijelova molimo vas da na dolje navedenu mail adresu pošaljete ovaj servisni obrazac. Na ovaj način mogu se dostaviti samo okovi. U slučaju da imate dodatne prigovore vezane uz komad namještaja molimo vas da se obratite izravno trgovini namještaja gdje je isti kupljen.

HU Direktszolgálatunk vasalatok esetén
Ha hiányzik egy vasalat, ezt a kártyát közvetlenül elküldheti az alább található címre. Azonban csak vasalatoskat tudunk így küldeni. Amennyiben másfajta reklamáció áll fenn bútordarabját illetően, forduljon közvetlenül a bútornához.

SK Naš priamy servis pre časti kovania
Ak by Vám chýbala nejaká časť kovania, môžete poslať túto servisnú kartu poslať e-mailom na nižšie uvedenú adresu. Diely kovania vieme poslať iba týmto spôsobom. Ak by ste mali inú reklamáciu ohľadom Vašho nábytku, obráťte sa priamo na Vašu predajňu nábytku.

SLO Naše direktno uslužne storitve za okovje
Če vam manjka kakšno okovje, lahko to servisno kartico pošljete po e-pošti direktno na spodnji naslov. Po tej poti vam lahko pošljemo samo okovje. Če imate reklamirani kakšen drug del pohištva, se obrnite neposredno na vašo trgovino pohištva.

RO Service-ul nostru direct pentru feronerie
În cazul în care vă lipsește o piesă de feronerie puteți să trimiteți direct acest card de service prin e-mail la adresa dePmai jos. Noi nu putem expedia piese de feronerie decât pe această cale. Dacă aveți o altă reclamație referitoare la piesa de mobilier, atunci vă rugăm să vă adresați direct la magazinul dvs. de mobilă.

RUS Наш прямой сервис для поставок фурнитуры
Если окажется, что Вам не хватает того или иного элемента фурнитуры, Вы можете отправить сервисную карту по факсу непосредственно на нижеприведенный адрес электронной почты. Однако, таким образом мы можем пересылать лишь фурнитуру. Если же у Вас возникнут иные претензии относительно приобретенной мебели, пожалуйста, обращайтесь непосредственно в организацию, осуществившую продажу.

S Vår direktservice för beslagsdelar
Om du saknar en beslagsdel kan du skicka detta servicekort direkt till e-postadressen som anges nedan. Tänk på att detta är den enda möjligheten att skicka beslagsdelar till dig. Om du vill reklamera din

ES Nuestro servicio directo para accesorios
Si le falta algún accesorio, puede enviar esta tarjeta de servicio directamente a la siguiente dirección. No obstante, por este método solo podemos enviar accesorios. Si tiene alguna otra objeción sobre su mueble, consulte directamente con su mueblería.

TR Donatılar için doğrudan servisimiz
Bir donatınız eksikse bu servis kartını doğrudan aşağıda bulunan adrese doğrudan mail yazabilirsiniz. Sadece bu yolla donatıları gönderebiliriz. Mobilyanızda başka şikayetleriniz varsa lütfen doğrudan mobilya satıcınıza danışın.

max.



253 256
254 255

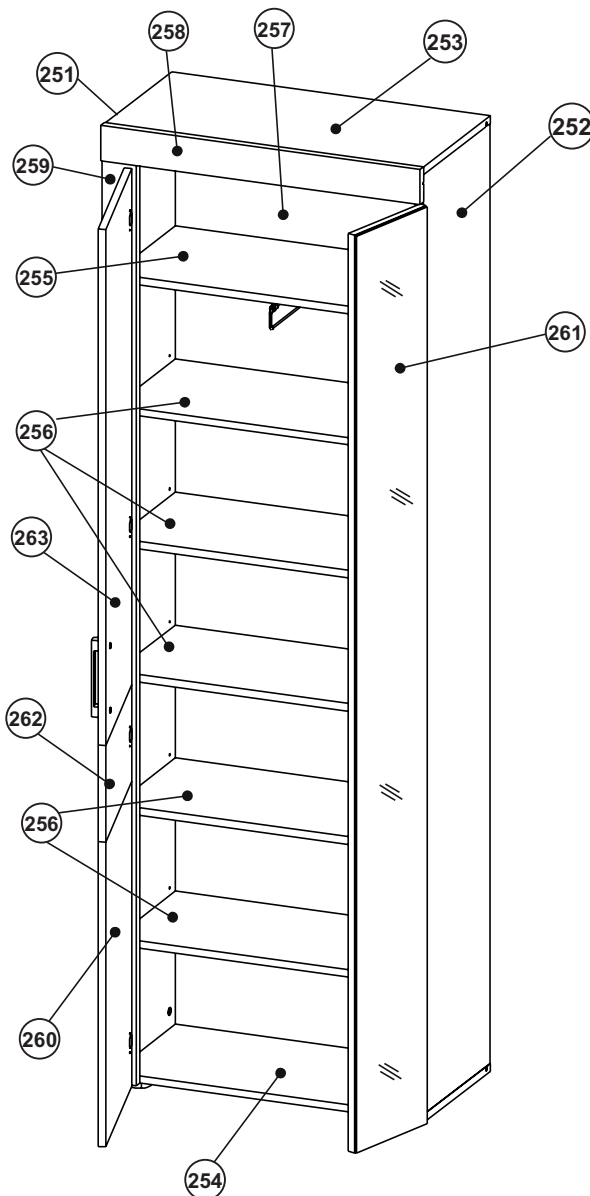

| A | B (mm) | | Colli | C |
|------|--------|-----|-------|--------|
| 251 | 1866 | 320 | 15 | 2/2 x1 |
| 252 | 1866 | 320 | 15 | 2/2 x1 |
| 253 | 650 | 320 | 15 | 1/2 x1 |
| 254 | 650 | 320 | 15 | 1/2 x1 |
| 255 | 618 | 298 | 15 | 1/2 x1 |
| 256 | 615 | 290 | 15 | 1/2 x5 |
| 257 | 1881 | 633 | 2,7 | 2/2 x1 |
| 258 | 650 | 70 | 18 | 1/2 x1 |
| 259 | 1827 | 70 | 18 | 2/2 x1 |
| 260 | 574 | 374 | 15 | 2/2 x1 |
| 261 | 1824 | 200 | 19 | 2/2 x1 |
| 262 | 250 | 374 | 15 | 2/2 x1 |
| 263 | 1027 | 374 | 15 | 2/2 x1 |
| B251 | | | | 1/2 |

Grund der Beanstandung / Cause for complaint:

Möbelhaus / Furniture store:

Kunde / Customer :

Telefon / Telephone:

PLZ / Postcode :

Ort / City:

Str. +Nr / Street address :

@E-Mail:

LKZ:80677

Modellname / Model name / Nom du modele / Modellnamn
Nome modello / Název modelu / Modelnaam / Ime modela
Número Modelo / Modell neve / Название модели/
Názov modelu / Ime modela / Denumire model /
Наименование на модела / Nazwa modelu

INDY

Modellnummer / Number / Numéro du modele
Numero / Номер на модела / Modello
Ěíslo modelu / Modell száma / Eíslo modelu
Številka modela / Număr model / Broj modela
Modelnummer / Numer modelu

1879-127-23

Type / Tipo / Típus / Typ / Тип / Tip

127

B251(Colli 1/2)

B52

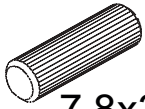

7,8x30 x12

A51

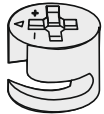

x8

M51



x20

O51

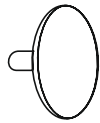

x8

C52

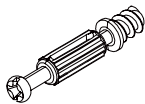

x8

N51

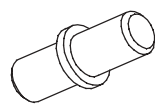

x20

R55



x4

P61

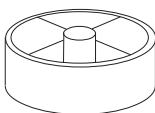

x4

D64



4x22 x4

P4



3,5x12 x4

Y4

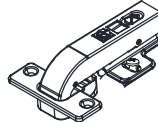

∅ 35 90° x4

D53



4x13 x16

K56

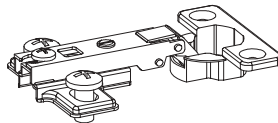

∅ 35 x4

Y87

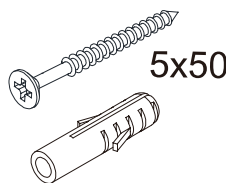

5x50

x1

I21



x1

DA70



3x14 x44

B54



7.8x50 x6

U21

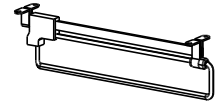

250 x1

DB52



4x30 x2

J108



164 x1

T51

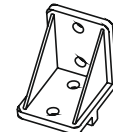

x10

J5

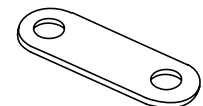

x1

F53

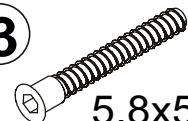

5,8x50 x4

FA51



4mm x1

D35



4x12 x2

P2



3x14 x2

S20



x2



ACHTUNG

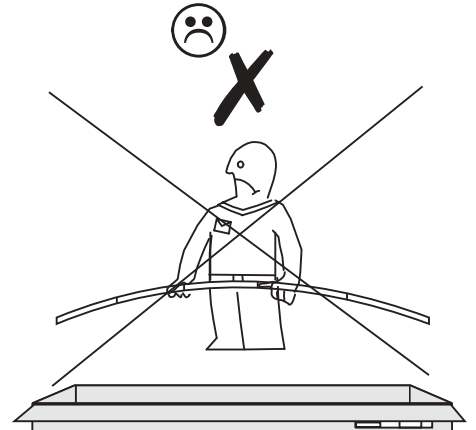
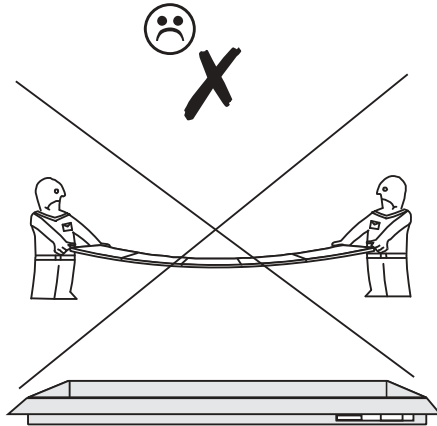

1

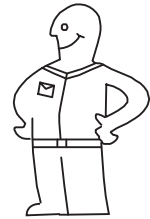
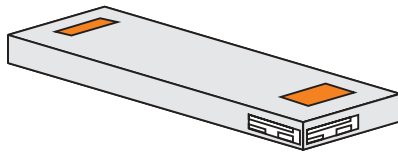

2

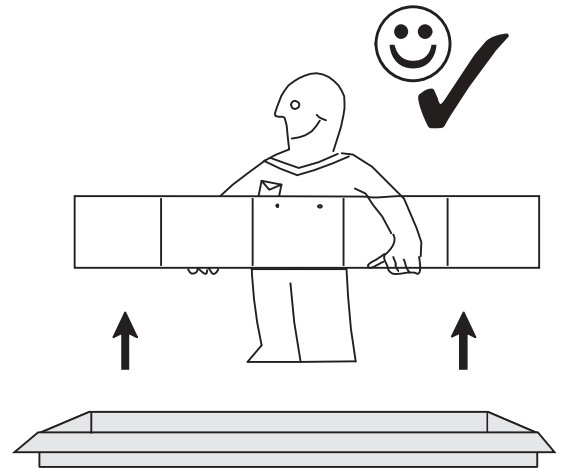
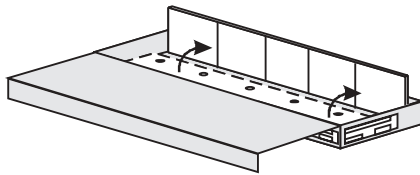

3

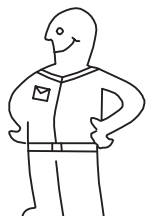
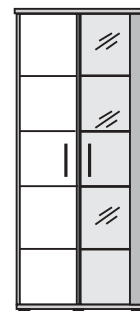
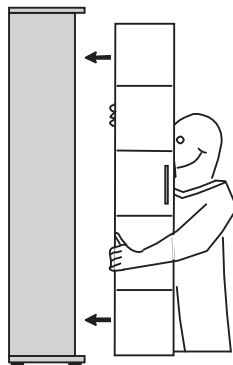

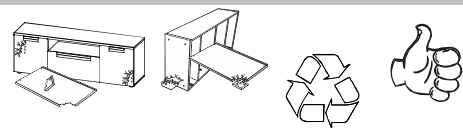
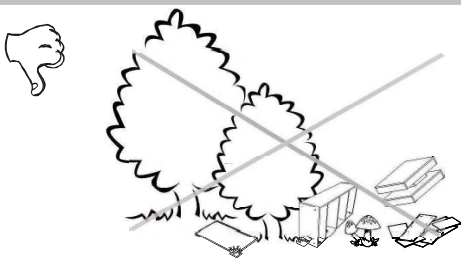
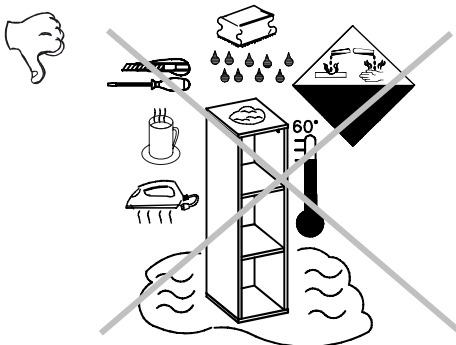
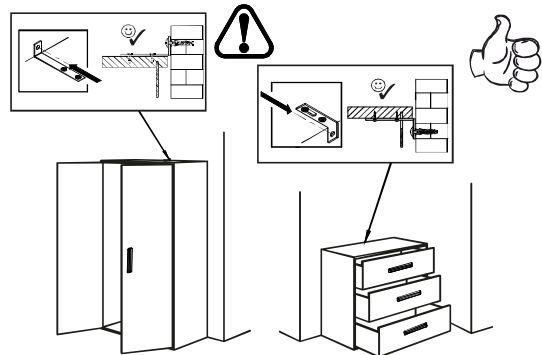
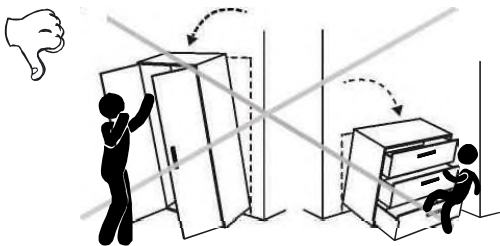
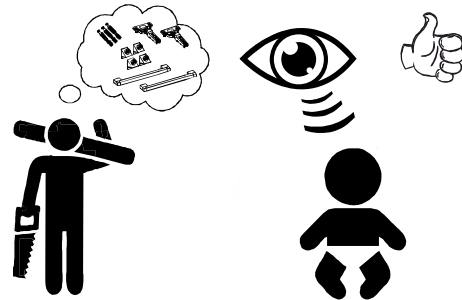
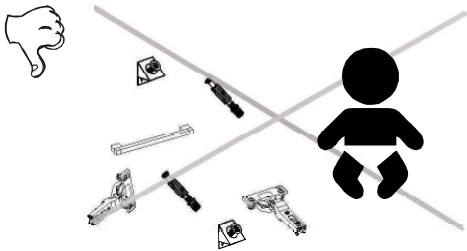
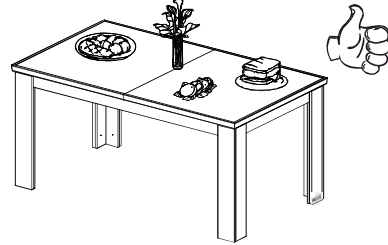
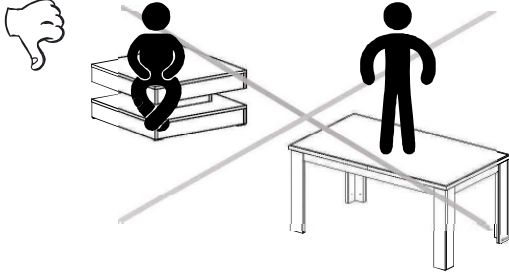
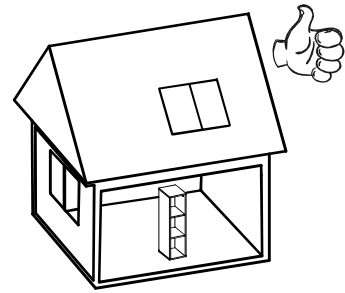





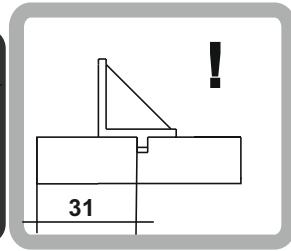
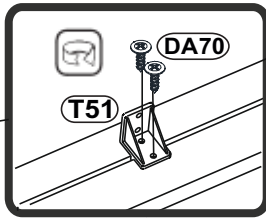
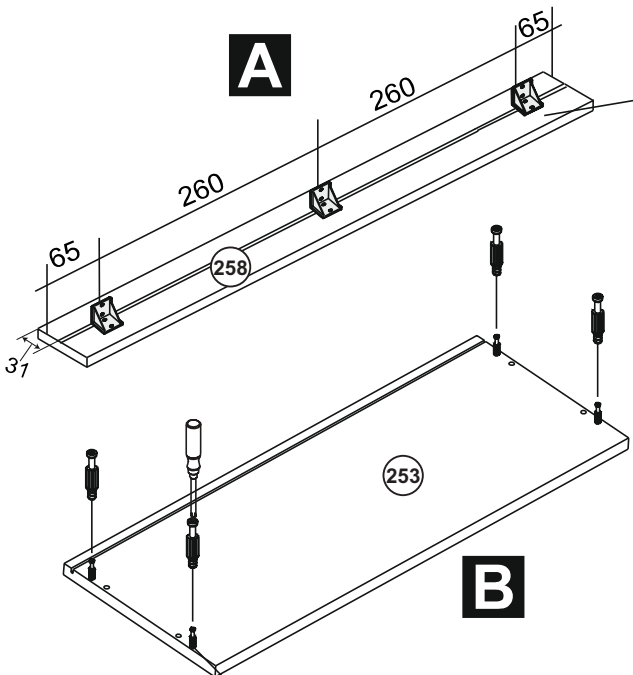

<https://quefairemesdechets.fr>



1





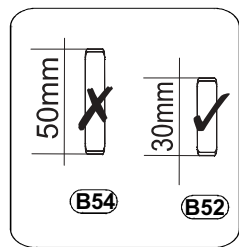
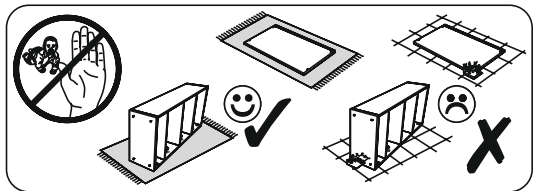
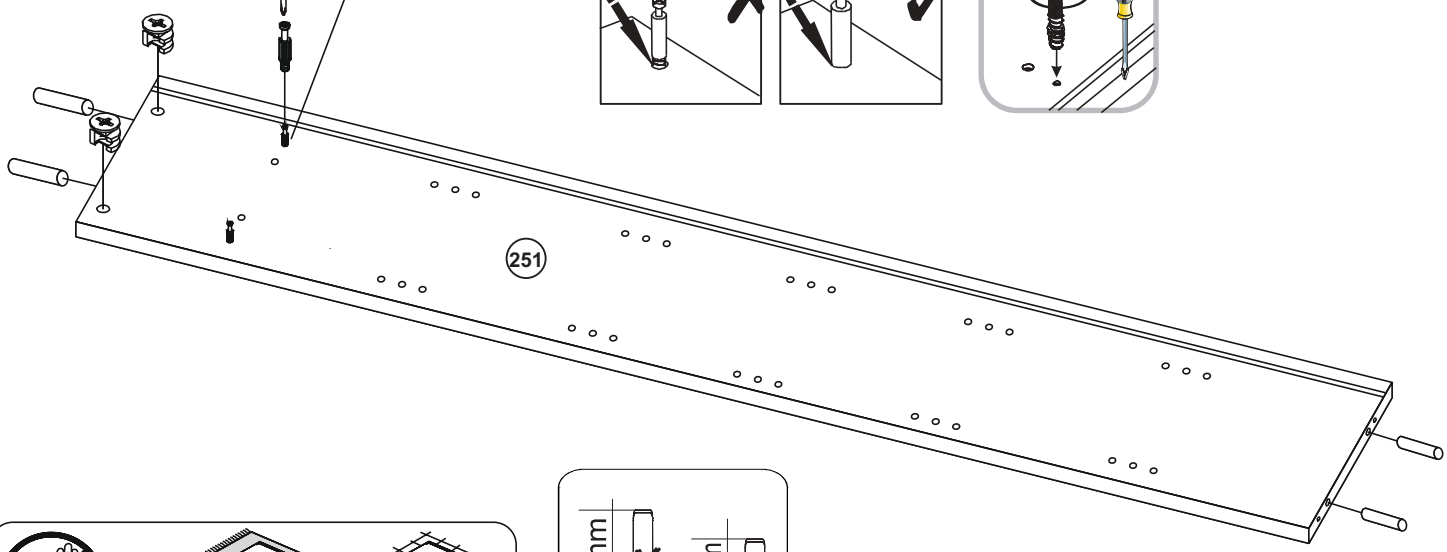
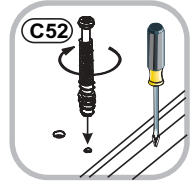
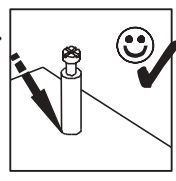
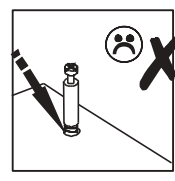
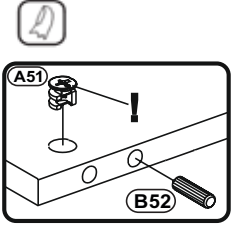
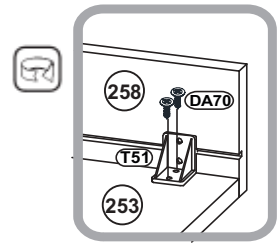
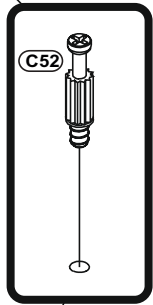
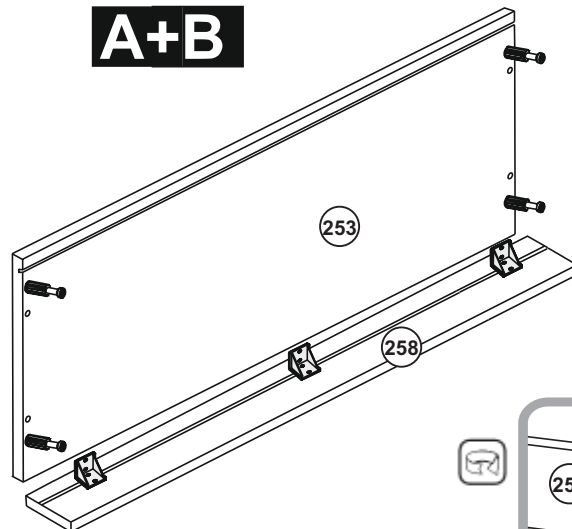

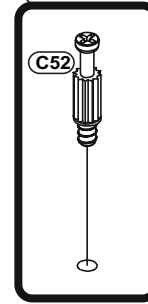
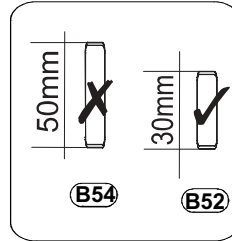
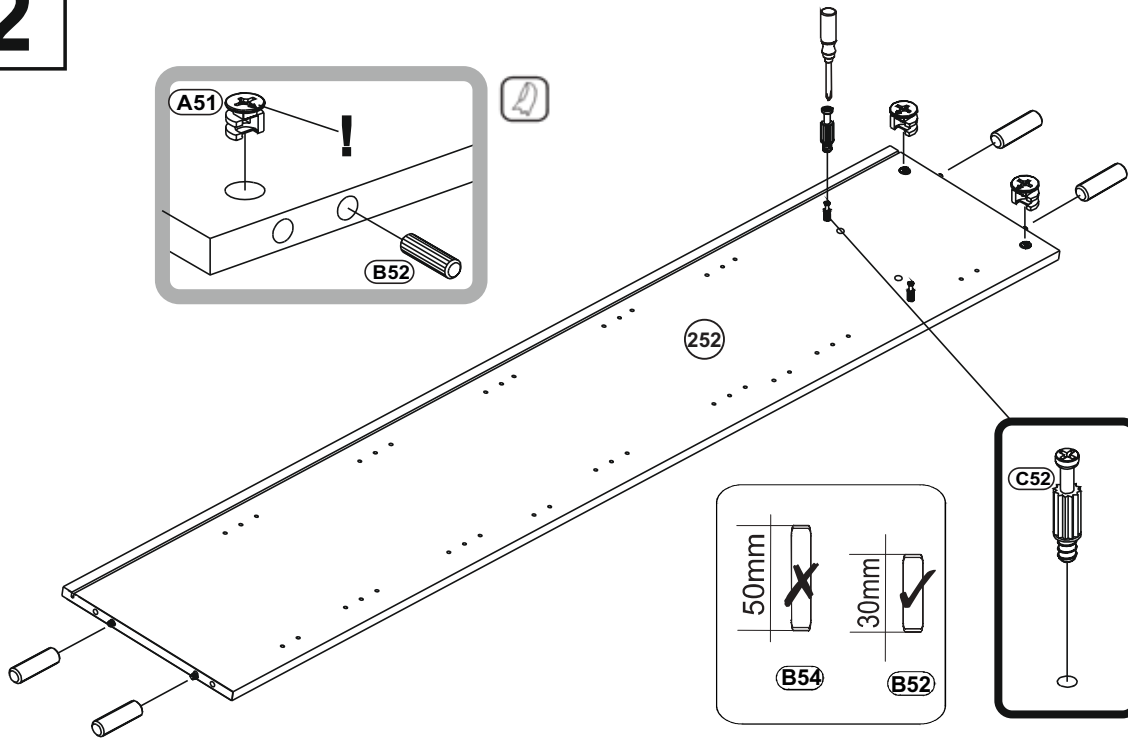
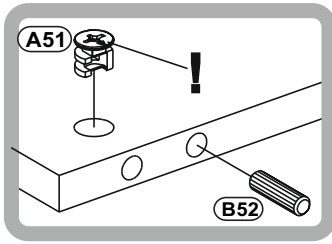

- B52**  7.8x30 x4
- A51**  x2
- C52**  x6
- T51**  x3
- DA70**  3x14 x12



2





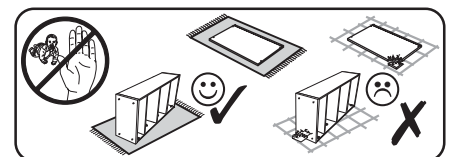
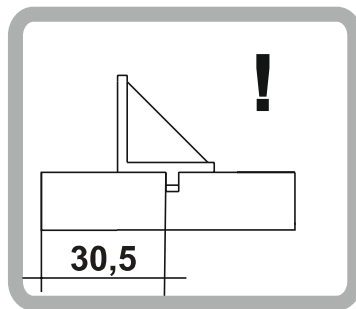
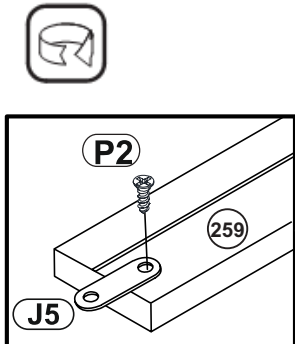
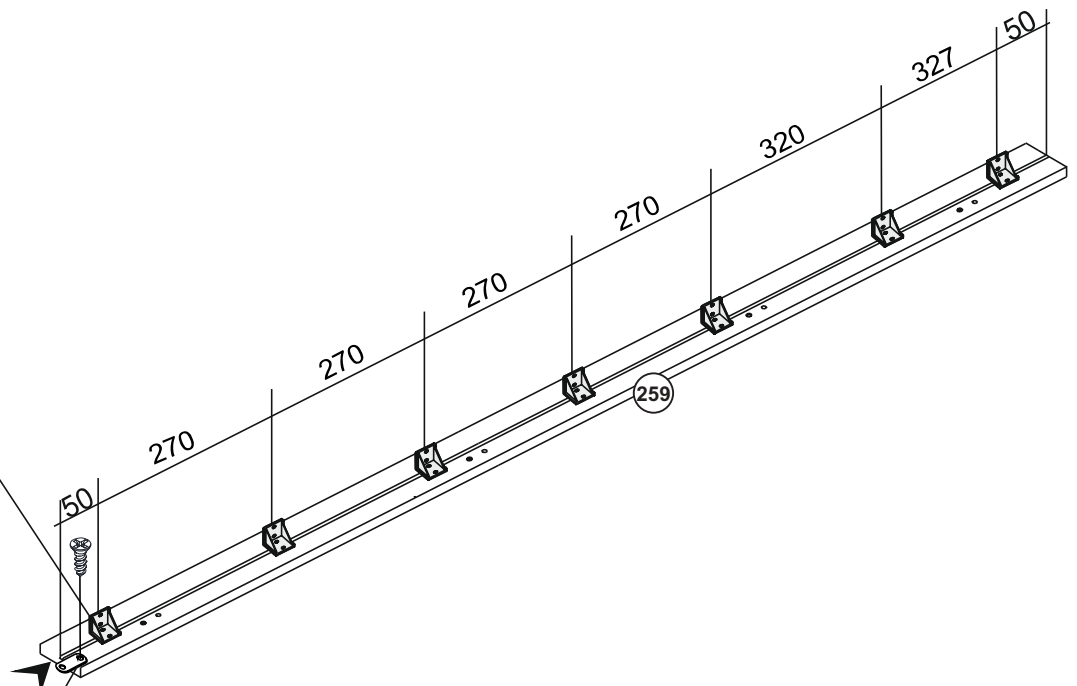
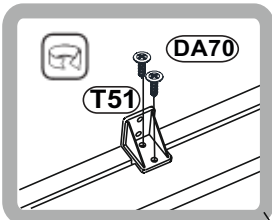
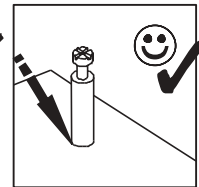
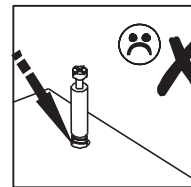



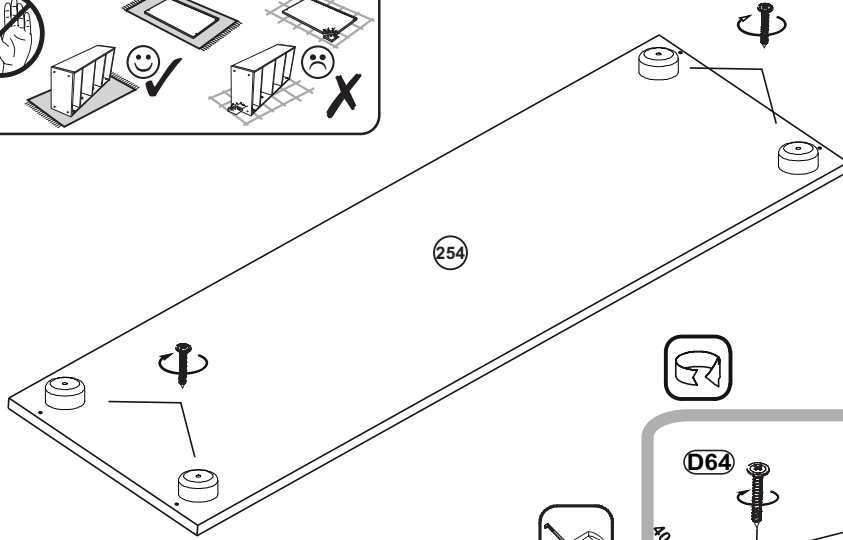
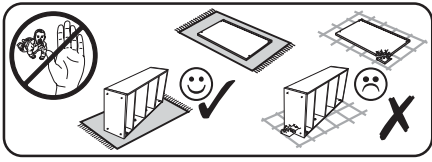

- A51**  x2
- B52**  7.8x30 x4
- C52**  x2
- T51**  x7
- DA70**  3x14 x14
- J5**  x1
- P2**  3x14 x1



3



- A51**  x4
- B52**  7,8x30 x4
- P4**  3,5x12 x4
- U21**  250 x1
- P61**  x4
- D64**  4x22 x4
- B54**  7.8x50 x6
- S20**  x2

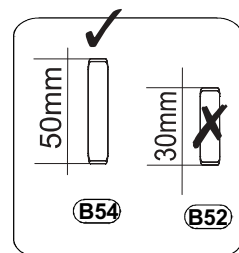
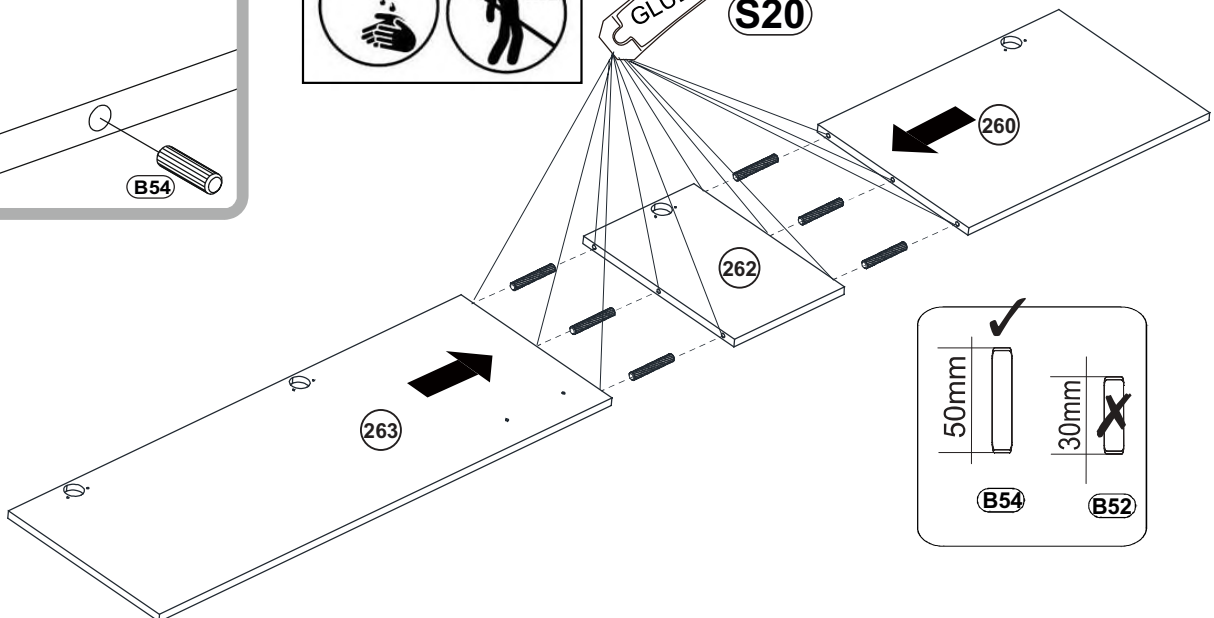
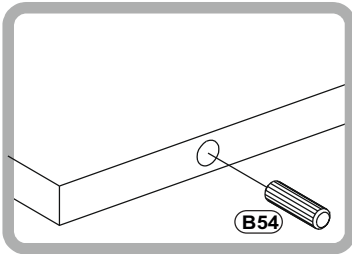
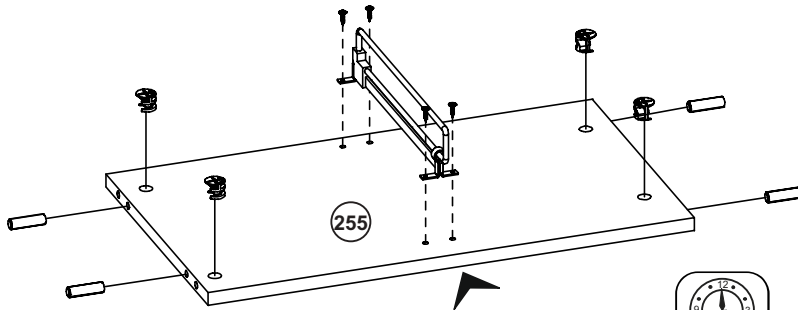
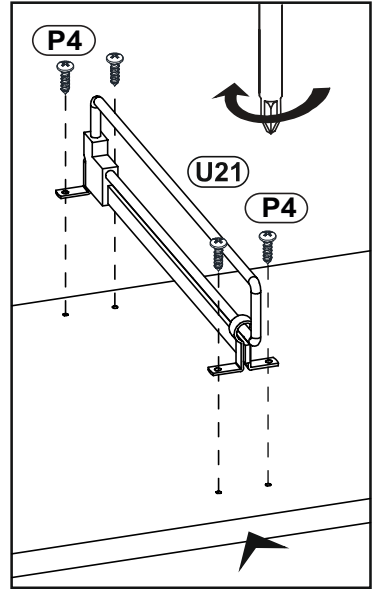
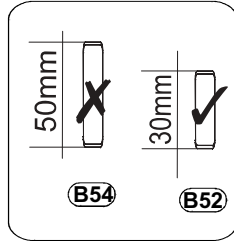
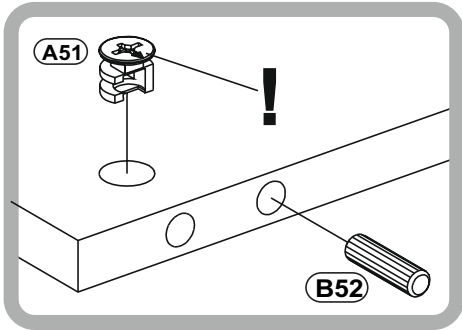
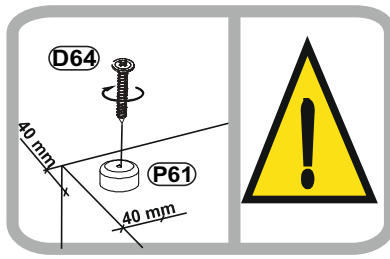

4

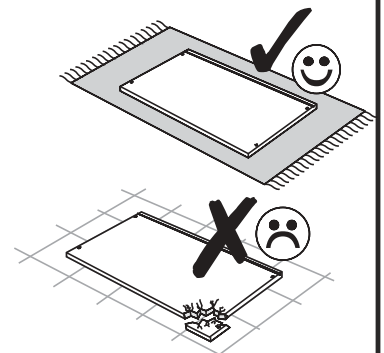
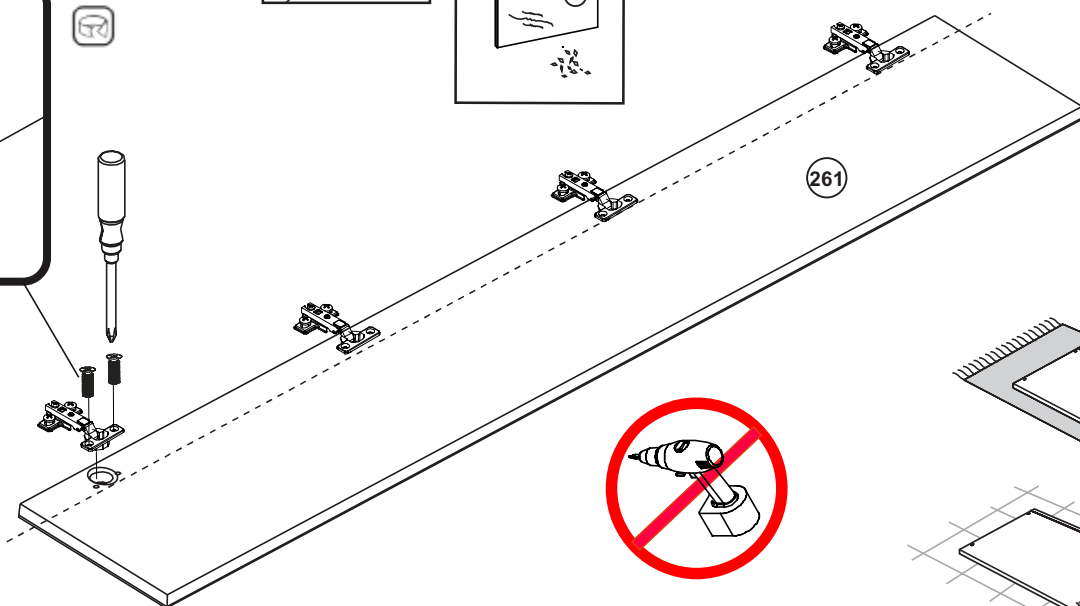
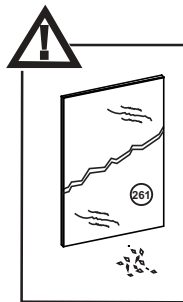
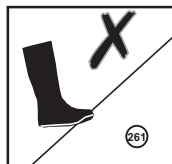
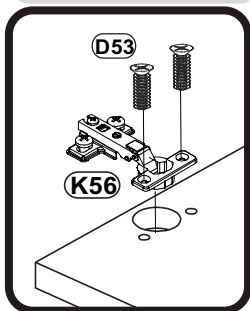
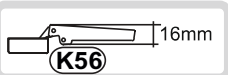
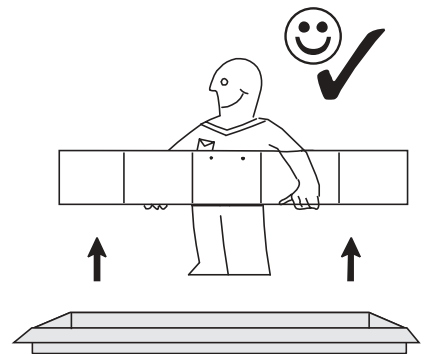
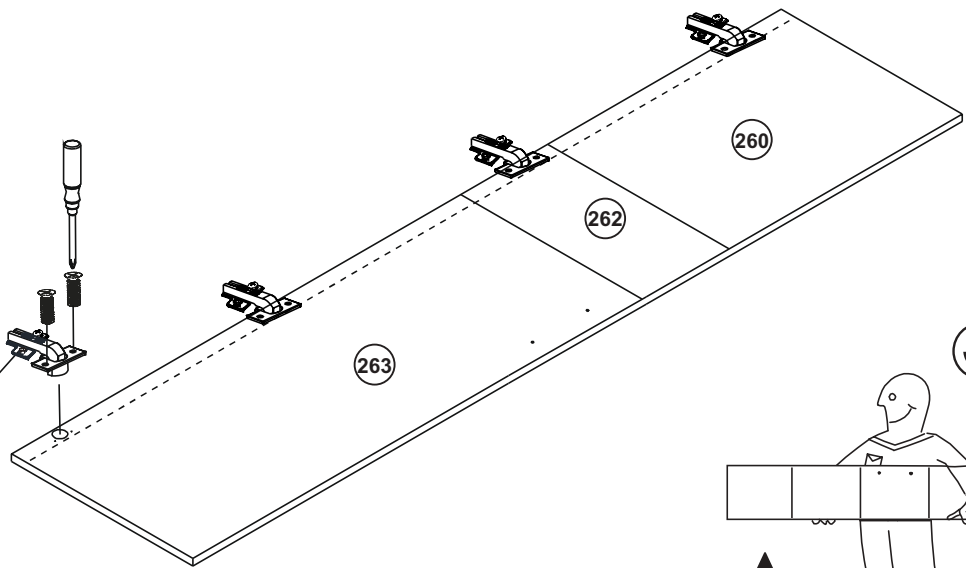
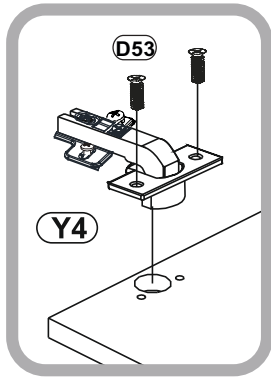
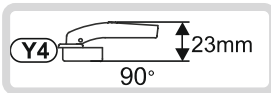
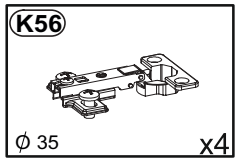
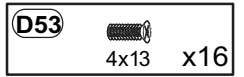
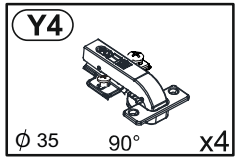
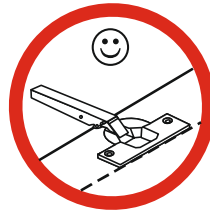
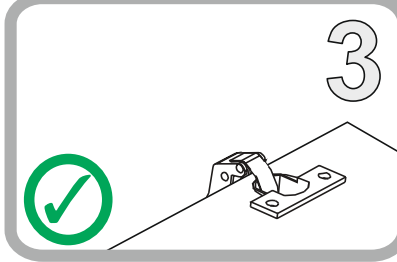
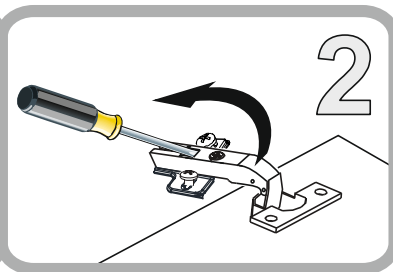
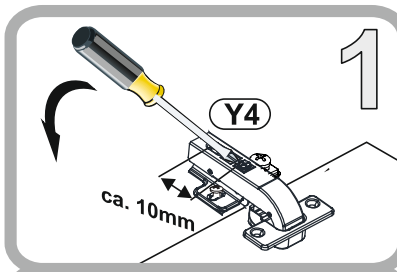

5

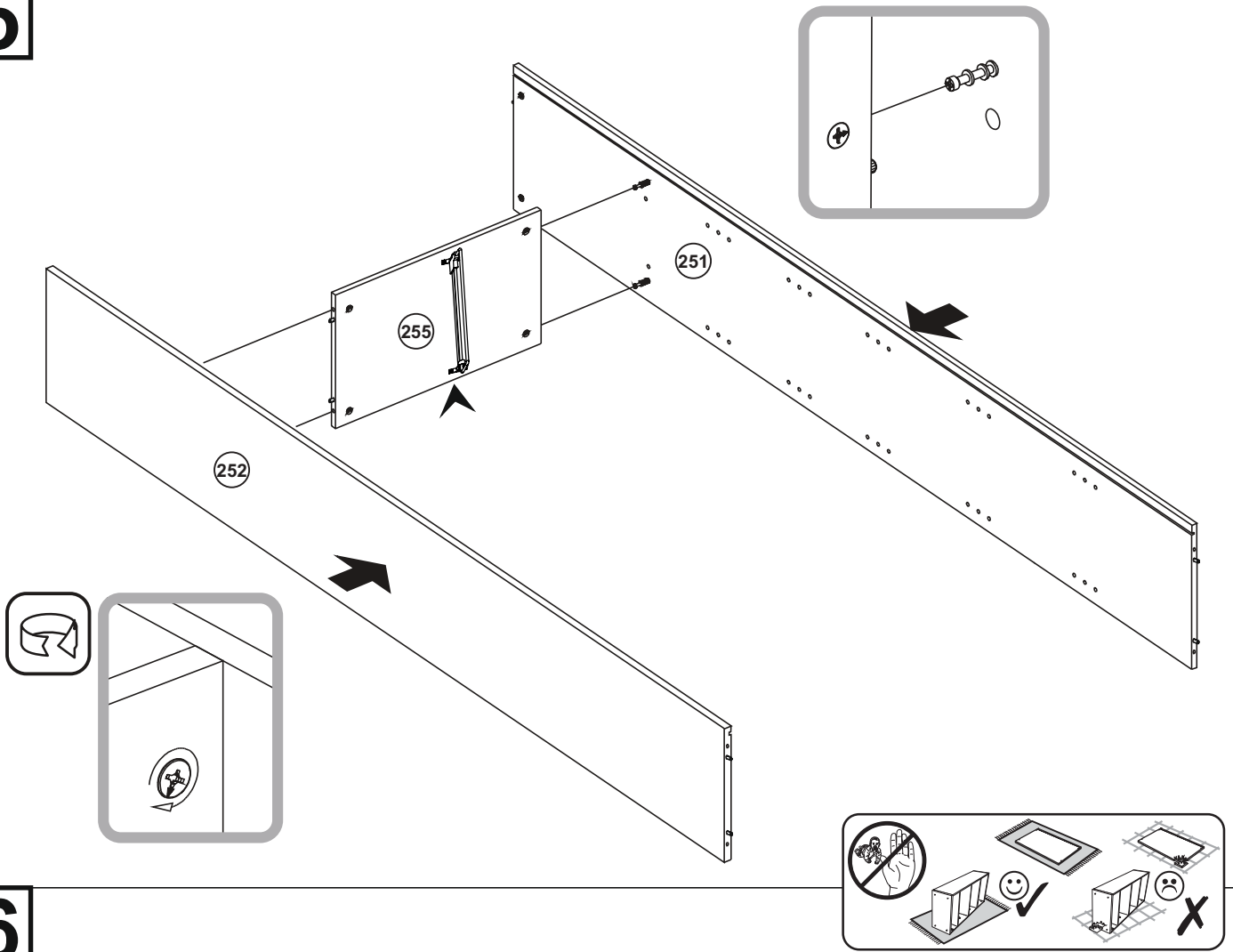

6

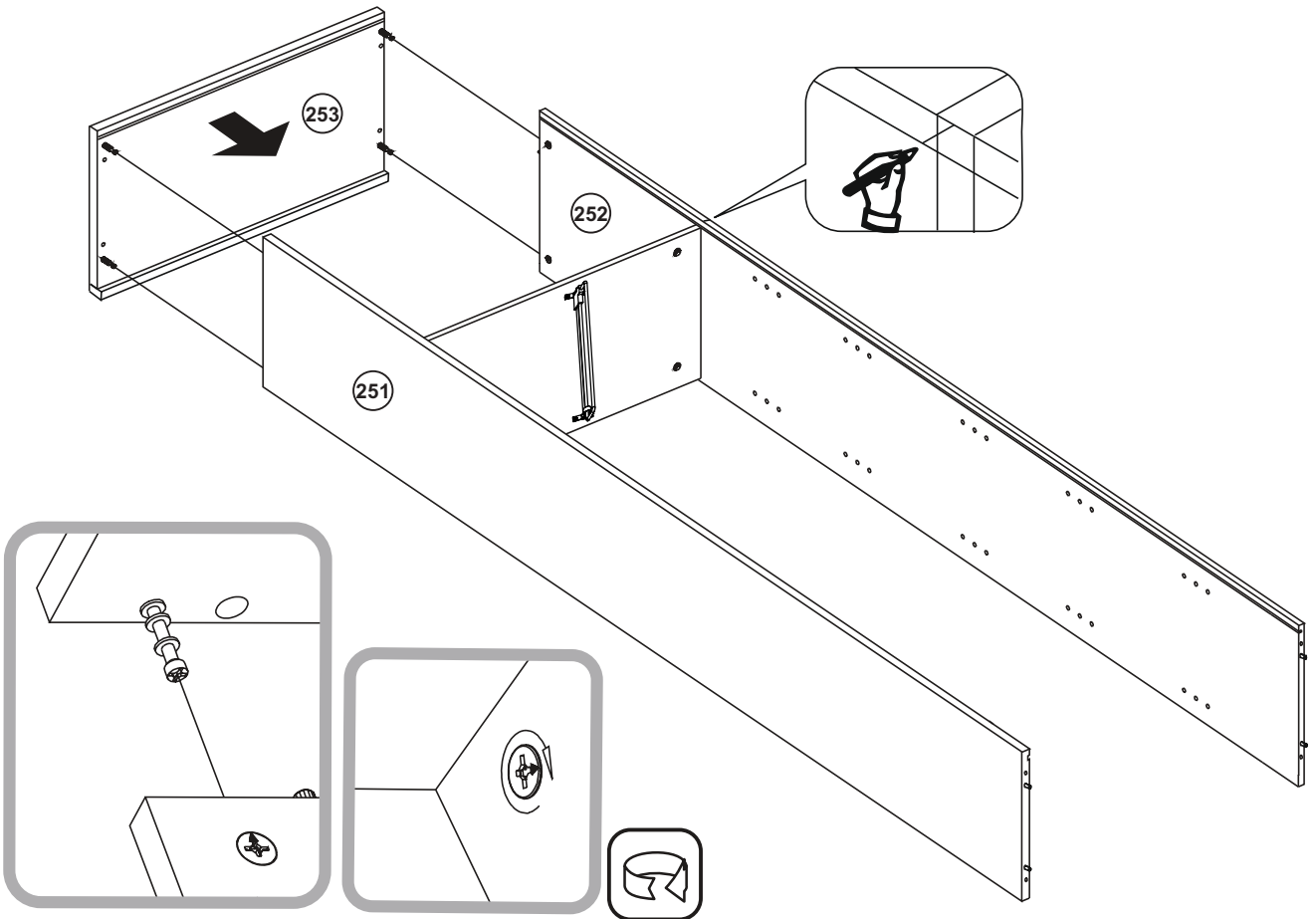

7

F53 5,8x50 x4

FA51 4mm x1

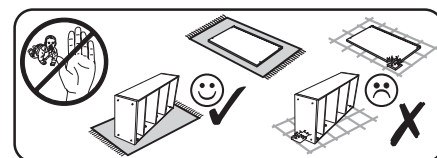
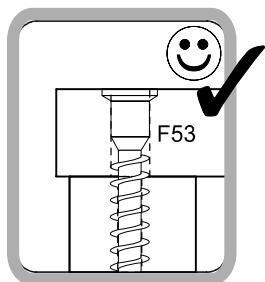
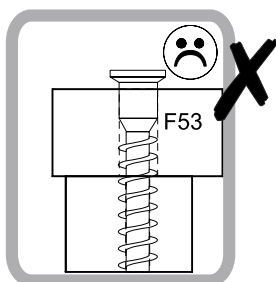
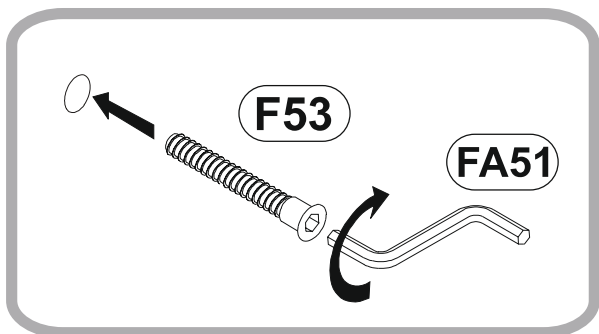
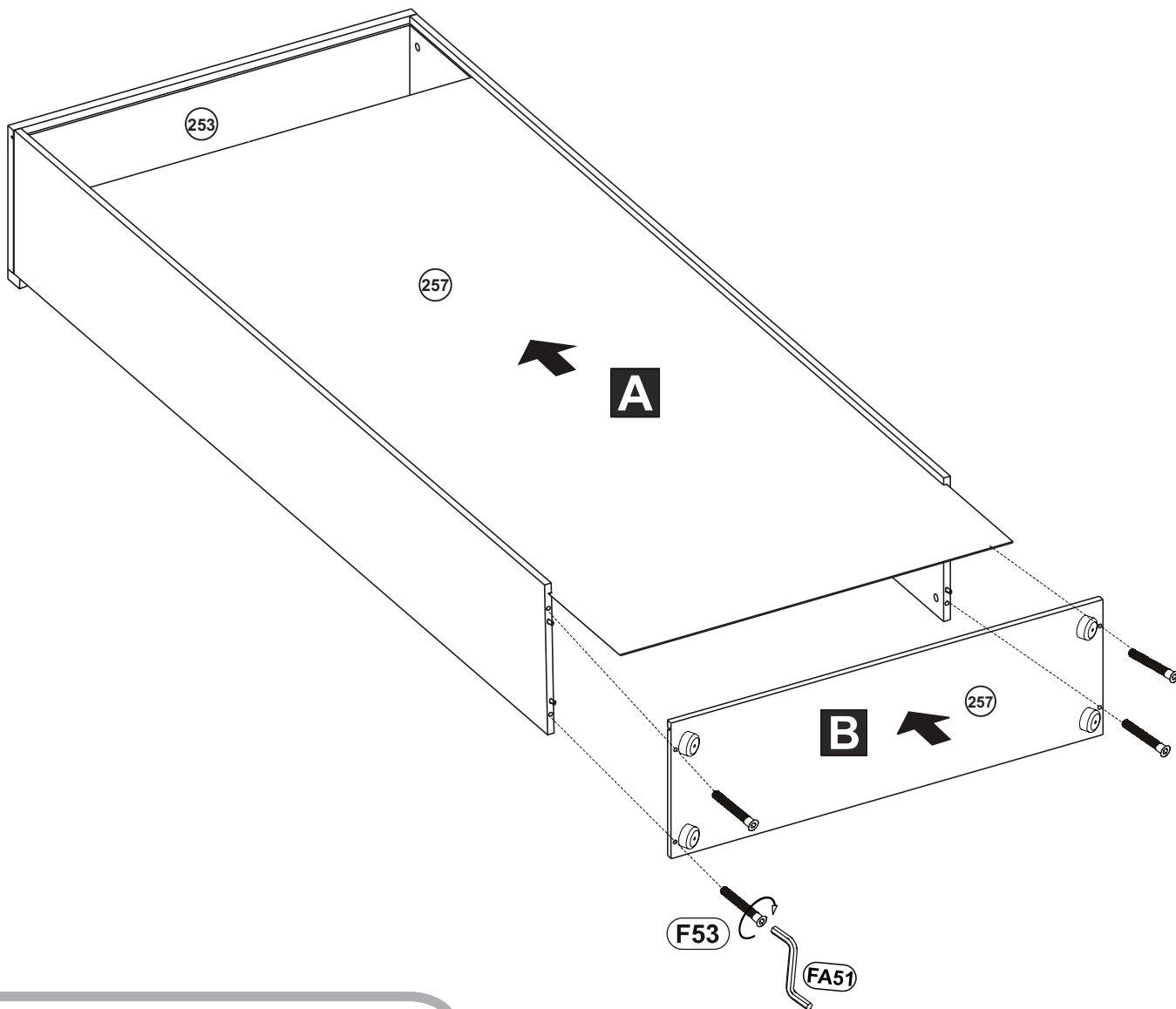

8

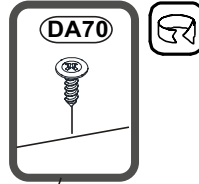
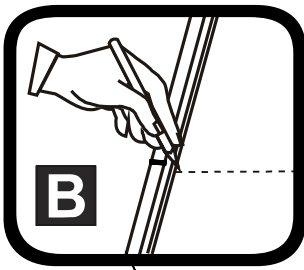

DA70 3x14 x18



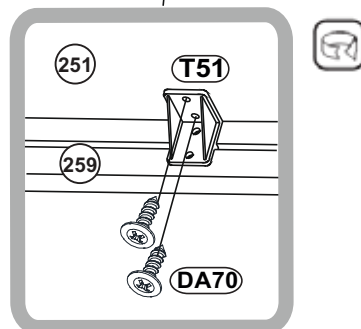
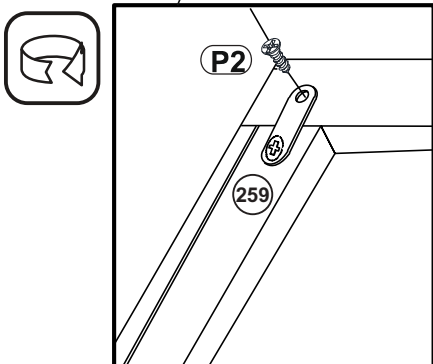
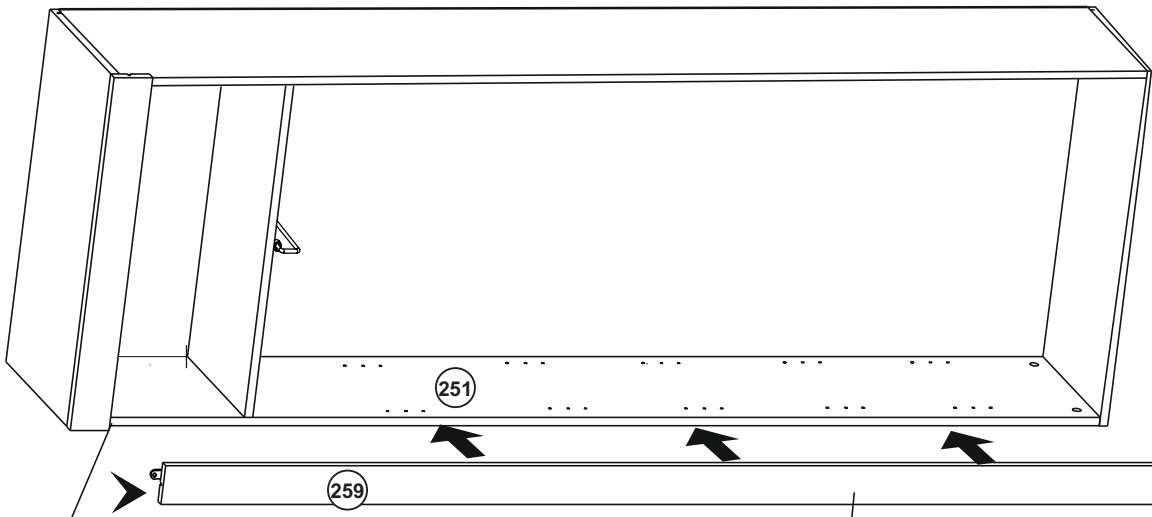
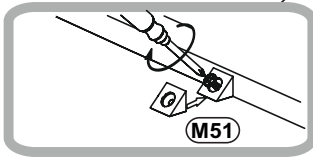
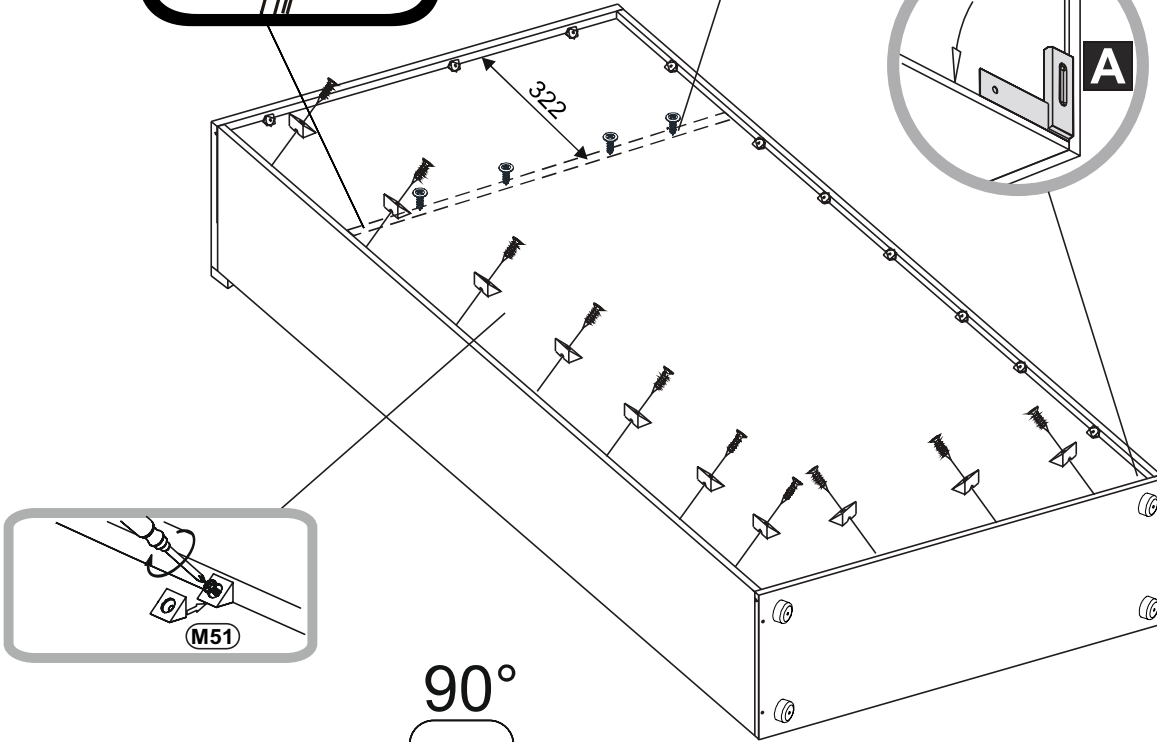
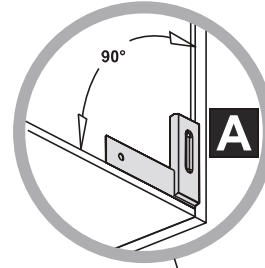

M51 3x16 x20

P2 3x14 x1

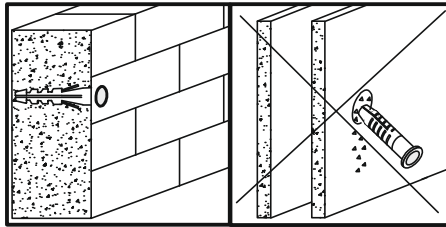

9



- Y87**  5x50 x1
- I21**  x1
- D35**  4x12 x2
- N51**  x20
- O51**  x8

C

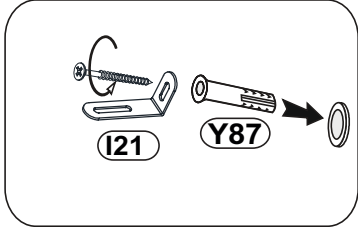

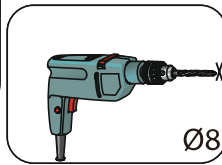

B

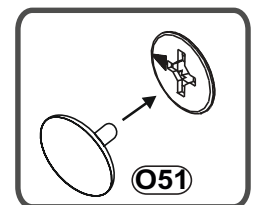
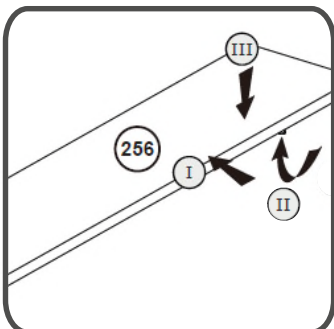
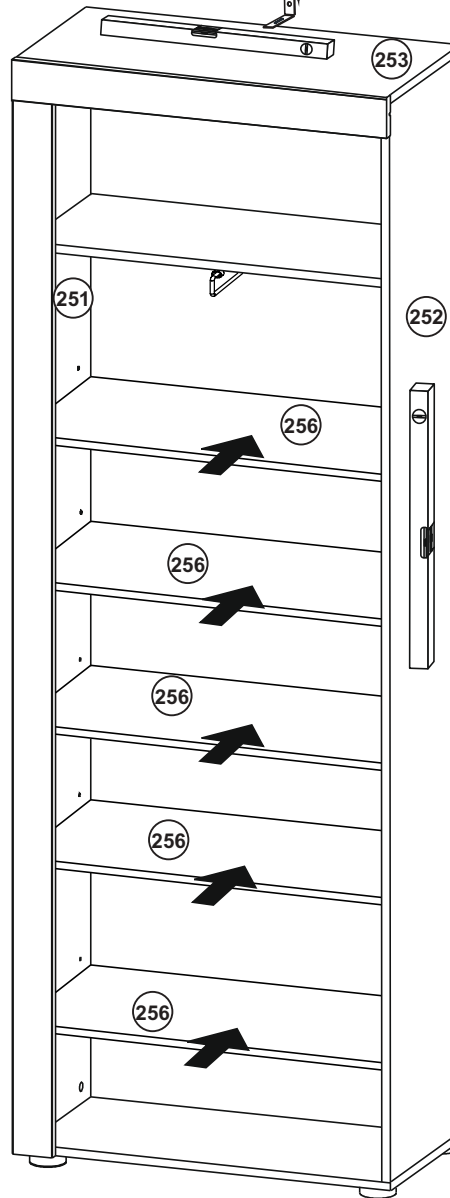
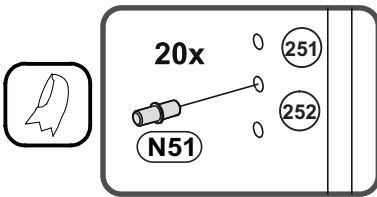
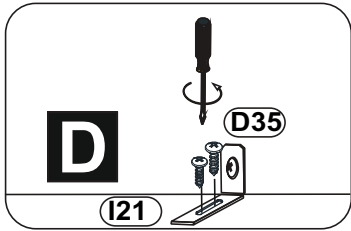
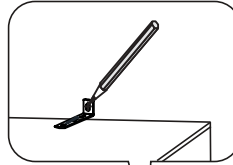

A



10

- R55**  x4
- J108**  x1
- DB52**  4x30 x2

