

LKZ:80677

Modellname / Model name / Nom du modele / Modellnamn / Nome modello / Název modelu / Modelnaam / Ime modela / Numéro Modelo / Modell neve / Название модели / Názov modelu / Ime modela / Denumire model / Наименование на модела / Nazwa modelu

INDY

Modellnummer / Number / Numéro du modele / Numero / Номер на модела / Modello / Éislo modelu / Modell száma / Eíslo modelu / Številka modela / Număr model / Broj modela / Modelnummer / Numer modelu

1879-310-23 

Type / Tipo / Típus / Typ / Тип / Tip

310

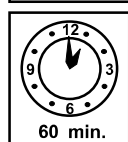
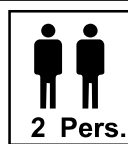
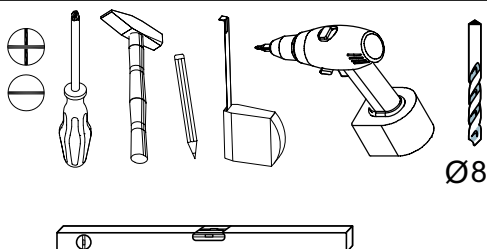
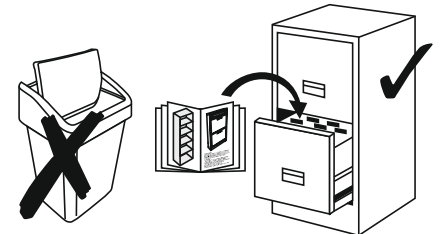
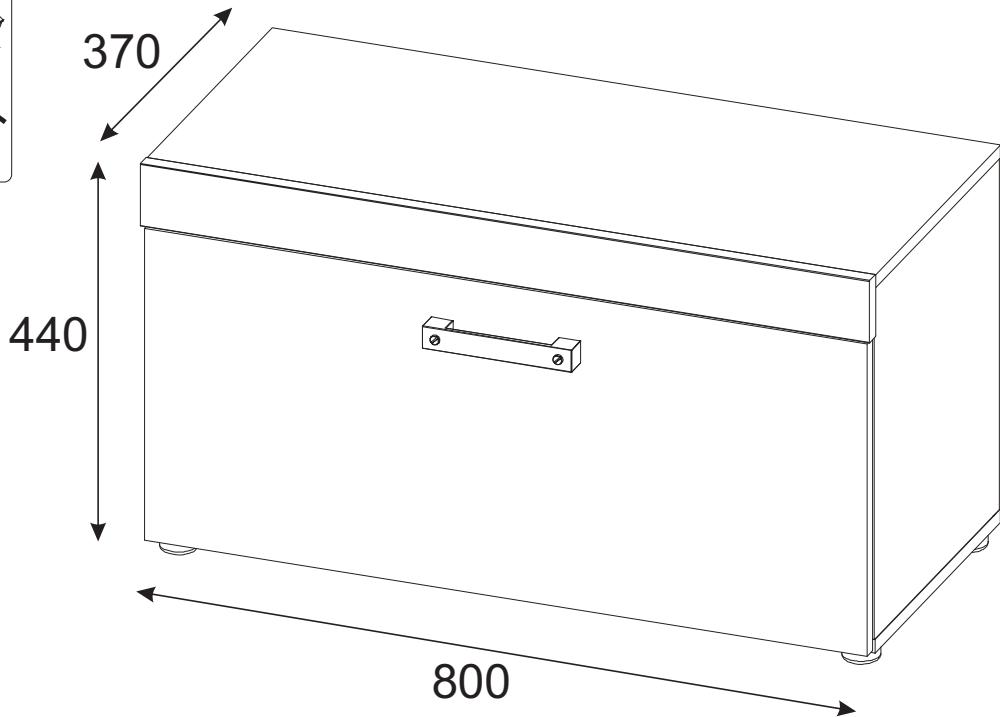
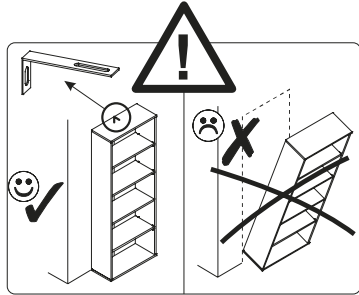
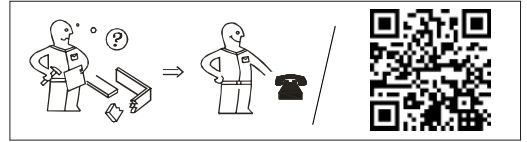
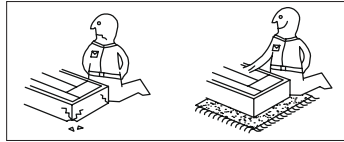
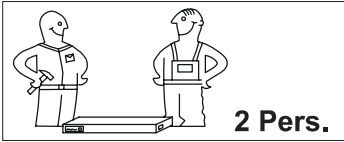

festziehen / tighten / Затягнeтe / serrer / stringere / utáhnout / vasttrekken / zategnuti / strángere / zwiázac / zacináç / szorosan meghúzni / pevne dotiahnut' / trdno pritegniti / затянуть / dra át

eindrücken / press in / enfoncer / wcisnaç / ribattere / zatlábit / Вeрабeдe / indrukken / benyomni / stáçit' / vtisniti / tryck in / introducere prin apásare / вдавить

ausmessen / measure / mesurer / misurare / opmeten / izmeriti / miara / kimérni / izmeriti / másurare / измерить / zméřit / Eçlepeðe / mät upp / zmierzyc



drücken / press / presser / stisknout / Натиснeтe / vtisniti / nasinac / drukken / pritisnuti / nacinac / pritisniti / нажать / (meg)nyomni / zapasare / tryck fast / nacisnaç

einschlagen / hammer in / beverni / sla in / frapper au marteau / infossare / Zabit' / zarazit / Набийте / zabiti / wbiç / introducere prin bâteale / забить / zatluout

Drehen - wenden /przekreçit' -odwróçit' / Keren - omdraaien / Girare - Ruotare / Okrenuti - ubnuti / Retourner - renverser / Turn over - turn around / Otocit'e - obratit'e / Zавъртeтe - обвъртeтe / Obrnite list / Întoarçeti - rotiti / Vrid runt - vänd / прокрутит'e - повернут' / otoèit - obrátit' / elforgatni - megfordítani

LKZ:80677

Modellname / Model name / Nom du modele / Modellnamn
Nome modello / Název modelu / Modelnaam / Ime modela
Número Modelo /Modell neve / Название модели/
Názov modelu / Ime modela / Denumire model /
Наименование на модела / Nazwa modelu

INDY

Modellnummer / Number / Numéro du modele
Numero / Номер на модела / Modello
Èislo modelu / Modell száma / Eíslo modelu
Številka modela / Număr model / Broj modela
Modelnummer / Numer modelu

1879-310-23

Type / Tipo / Típus / Typ / Тип / Tip

310

D Unser Direktservice für Beschlagteile
Sollte Ihnen ein Beschlagteil fehlen, können Sie diese Servicekarte
direkt an die untenstehende Adresse mailen. Wir können allerdings
nur Beschlagteile auf diesem Wege verschicken. Sollten Sie eine
andere Beanstandung an Ihrem Möbelstück haben, so wenden sie
sich bitte direkt an Ihr Möbelhaus.

GB Our direct order service for fitting
If a fitting part is missing, you can e-mail this service card directly
to the address below. However, we can only send fitting parts in
this way. If you have any other cause for complaint concerning
your item of furniture, please contact your furniture store directly.

CZ Naše přímé služby pro kování
Chybí-li vám nějaký díl z kování, můžete tuto servisní kartu odeslat
e-mailem přímo na níe uvedenou adresu. Touto cestou však
můžeme rozesílat jen díly kování. Pokud byste reklamovali jiný díl
nábytku, obraťte se přímo na svého prodejce nábytku.

F Bien étudier la notice de montage
S'il vous manque une ferrure, veuillez envoyer directement la présente
carte service à l'adresse e-mail indiquée ci-dessous. Cependant, ceci
nous permet uniquement d'envoyer des ferrures. Pour tout autre type
de réclamation concernant votre meuble, veuillez contacter
directement votre magasin d'ameublement.

I Il nostro servizio diretto per l'ordine della ferramenta
Qualora Vi dovesse mancare un pezzo di fissaggio, allora Vi
preghiamo di inviare questa carta di servizio immediatamente
all'indirizzo sottostante. Possiamo inviare i pezzi di fissaggio
solamente per mezzo di questo procedimento. Qualora dovete
avere qualche altra reclamazione in merito al mobile, allora Vi
preghiamo di rivolgeri direttamente al Vostro Negozio di mobili.

BG Нашата директна услуга за обков
Ако липсват части от комплекта, попълнете настоящата
сервисна карта и ни я изпратете на e-mail адреса, посочен
по-долу. По този начин можем да доставяме само липсващи
елементи от обкова. Ако установите други дефекти по
мебелите, Ви съветваме да се обърнете към мебелната
къща/магазин, от който сте закупили стоката.

NL Onze directservice voor losse onderdelen
Wanneer er een onderdeel ontbreekt, kunt u deze servicekaart
direct aan onderstaand e-mailadres sturen. Wij kunnen langs deze
weg echter alleen beslagdelen versturen. Mocht u een ander
probleem aan uw meubel hebben, verzoeken wij u contact op te
nemen met uw meubeldealer.

PL Nasz bezpośredni serwis części montażowych
Jeżeli brakuje części koniecznych do montażu, prosimy o przesłanie
nam niniejszej karty serwisowej na niżej podany adres e-mailowy.
W ten sposób możemy przesyłać Państwu tylko brakujące części.
W przypadku innych reklamacji dotyczących mebla, prosimy zgłosić
się do salonu meblowego, w którym został dokonany zakup.

HR Servis za okove
U slučaju da nedostaje neki od dijelova molimo vas da na dalje
navedenu mail adresu pošaljete ovaj servisni obrazac. Na ovaj način
mogu se dostaviti samo okovi. U slučaju da imate dodatne prigovore
vezane uz komad namještaja molimo vas da se obratite izravno
trgovini namještaja gdje je isti kupljen.

HU Direktszolgáltatunk vasalatok esetén
Ha hiányzik egy vasalat, ezt a kártyát közvetlenül elküldheti az
alább található címre. Azonban csakis vasalatoakat tudunk így
küldeni. Amennyiben másfajta reklamáció áll fenn bútorárbaját
illetően, forduljon közvetlenül a bútorházához.

SK Náš priamy servis pre časti kovania
Ak by Vám chýbala nejaká časť kovania, môžete poslať
túto servisnú kartu poslať e-mailom na nižšie uvedenú
adresu. Diely kovania vieme poslať iba týmto spôsobom.
Ak by ste mali inú reklamáciu ohľadom Vášho nábytku,
obráťte sa priamo na Vašu predajňu nábytku.

SLO Naše direktno uslužne storitve za okovje
Če vam manjka kakšno okovje, lahko to servisno kartico pošljete
po e-pošti direktno na spodnji naslov. Po tej poti vam lahko
pošljemo samo okovje. Če elite reklamirati kakšen drug del
pohištva, se obrnite neposredno na vašo trgovino pohištva.

RO Service-ul nostru direct pentru feronerie
În cazul în care vă lipsește o piesă de feronerie puteți să trimiteți
direct acest card de service prin e-mail la adresa de mai jos. Noi
nu putem expedia piese de feronerie decât pe această cale.
Dacă aveți o altă reclamație referitoare la piesa de mobilier,
atunci vă rugăm să vă adresați direct la magazinul dvs. de mobilă.

RUS Наш прямой сервис для поставок фурнитуры
Если окажется, что Вам не хватает того или иного элемента
фурнитуры, Вы можете отправить сервисную карту по факсу
непосредственно на нижеприведенный адрес электронной
почты. Однако, таким образом мы можем пересылать лишь
фурнитуру. Если же у Вас возникнут иные претензии относительно
приобретенной мебели, пожалуйста, обращайтесь
непосредственно в организацию, осуществившую продажу.

S Vår direktservice för beslagsdelar
Om du saknar en beslagsdel kan du skicka detta servicekort direkt
till e-postadressen som anges nedan. Tänk på att detta är den enda
möjligheten att skicka beslagsdelar till dig. Om du vill reklamera din

ES Nuestro servicio directo para accesorios
Si le falta algún accesorio, puede enviar esta tarjeta de servicio directamente
a la siguiente dirección. No obstante, por este método solo podemos
enviar accesorios. Si tiene alguna otra objeción sobre su mueble, consulte
directamente con su mueblería.

TR Donatılar için doğrudan servisimiz
Bir donatınız eksikse bu servis kartını doğrudan aşağıda bulunan adrese
doğrudan mail yazabilirsiniz. Sadece bu yolla donatıları gönderebiliriz.
Mobilyanızda başka şikayetleriniz varsa lütfen doğrudan mobilya satıcınıza
danışın.

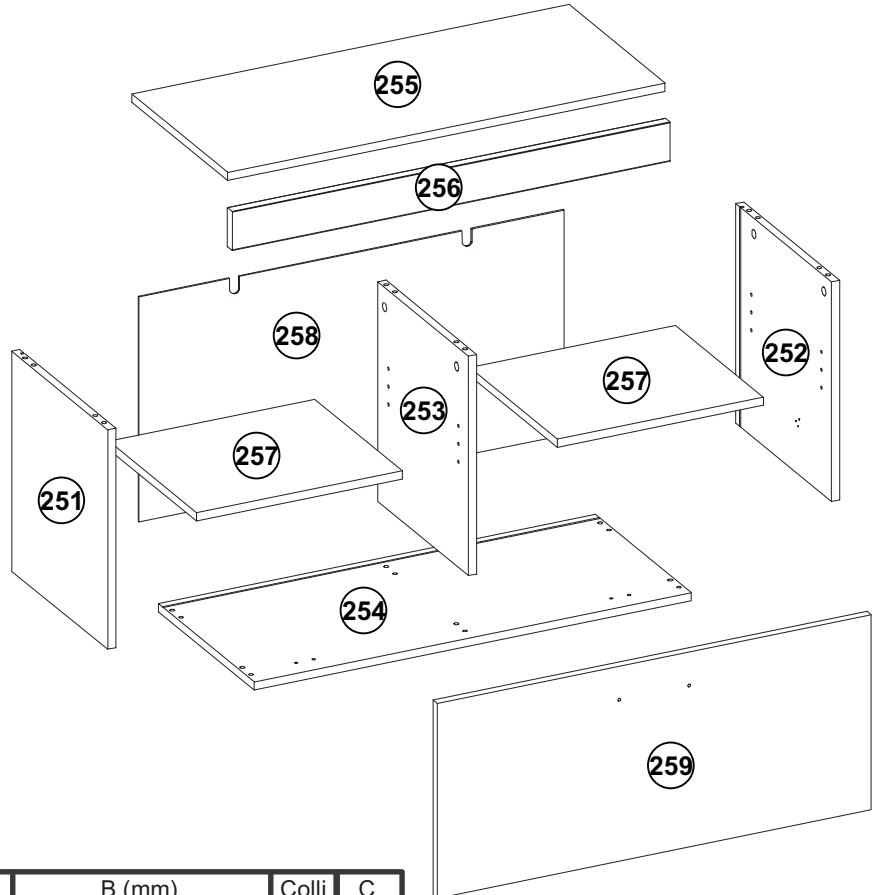
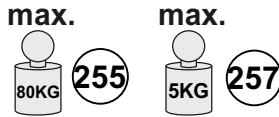

A	B (mm)		Colli	C
251	390	352	15	1/1 x1
252	390	352	15	1/1 x1
253	390	331	15	1/1 x1
254	800	352	15	1/1 x1
255	800	352	15	1/1 x1
256	800	70	18	1/1 x1
257	374	320	15	1/1 x2
258	783	405	2,7	1/1 x1
259	800	347	15	1/1 x1
B251				1/1

Grund der Beanstandung / Cause for complaint:

Möbelhaus / Furniture store:

Kunde / Customer :

Telefon / Telephone:

PLZ / Postcode :

Ort / City:

Str. +Nr / Street address :

@E-Mail:

LKZ:80677

Modellname / Model name / Nom du modele / Modellnamn
Nome modello / Název modelu / Modelnaam / Ime modela
Número Modelo / Modell neve / Название модели/
Názov modelu / Ime modela / Denumire model /
Наименование на модела / Nazwa modelu

INDY

Modellnummer / Number / Numéro du modele
Numero / Номер на модела / Modello
Ěíslo modelu / Modell száma / Eíslo modelu
Številka modela / Număr model / Broj modela
Modelnummer / Numer modelu

1879-310-23

Type / Tipo / Típus / Typ / Тип / Tip

310

B251

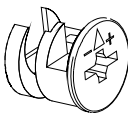
A51  15x12
x6

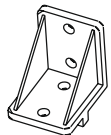
T51  x3

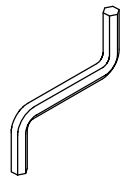
FA51  4mm x1

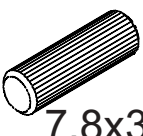
B52  7,8x30 x12

DA70  3x14 x14

J108  164mm x1

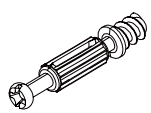
C52  x6

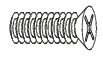
D53  4x13 x4

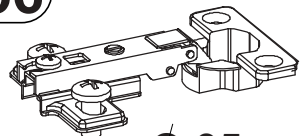
K56  Ø 35 x2

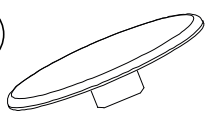
O51  Ø 17 x6

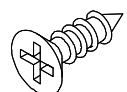
D61  3,5x12 x5

M51  3x16 x6

D64  4x22 x5

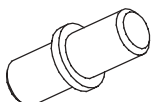
N51  x8

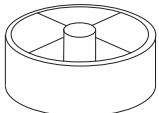
P61  x5

DB52  4x30 x2

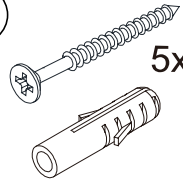
Y87  5x50 x2

R51  x1

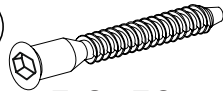
F53  5.8x50 x6

D35  4x12 x4

I21  x2

R55  x2

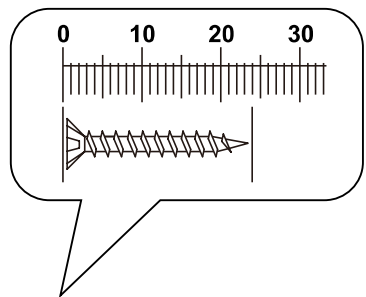

EN	ES	ET	FR
<p>Dear valued customer, Thank you for purchasing furniture from our interior programme, exclusively for use in private rooms. Please check the delivery for completeness, carefully read the following important information prior to assembly and retain it for future use, also by third parties. Our furniture may only be used as intended. Improper use can cause damage to property, or personal injury under certain circumstances. Furniture is not a toy. The manufacturer or distributor assumes no liability for damage caused by unintended use or improper handling. ATTENTION: Children or persons with a mental disability must be kept away from furniture components, sharp objects, small parts and packaging materials at all times. There is a risk of injury and/or suffocation. ASSEMBLY: Please observe our operating, assembly or installation instructions for assembly and observe the warnings and safety instructions in particular. Failure to follow instructions may lead to personal injury or damage to the furniture, and can pose a safety risk. Please contact our service team if you have problems with setup/assembly. They will be happy to help you. Assembly may only be carried out by competent persons. No liability for damage is assumed in case of changes to the product/product components or the replacement/use of parts/consumables not provided by the manufacturer/distributor. If wall mounting materials such as dowels or screws are included with the product, these are intended exclusively for use on solid walls made of uniform materials. Attachment is only as good as the connection between the mounting materials and the wall. For both standing and hanging furniture, check your wall for suitability prior to attachment and only use suitable mounting materials. Ensure there are no lines in the drilling zone before drilling any holes. Ultimately, the installer is responsible for the attachment to the wall. This also applies to the installation of electrical appliances and other structural accessories. The assembly/installation of electrical appliances and other structural accessories must be performed exclusively by authorised, qualified personnel. All electrical and structural installations must be carried out according to the respective applicable standards and safety regulations in your federal state. Only use approved illuminants for light sources. There is a risk of overheating and fire if the maximum wattage is exceeded. Covering illuminants is prohibited due to the risk of fire. Proper functioning of the furniture requires plumb and horizontal alignment. The doors are pre-adjusted, but may have to be readjusted due to local conditions. Be sure to observe the weight specifications for maximum loads. Climbing on furniture is prohibited. Furniture may tip over in case of improper use. To prevent this, furniture should always be secured against tipping over. There is a risk of breakage and injury in case of overloading (in particular by playing children, people, materials or other prohibited loads). All screws and load-bearing connections should be re-tightened after 5 to 6 weeks to ensure permanent stability. CARE: - Notes on furniture care - Please observe our information on proper furniture care to ensure you can enjoy our product for a long time. Use a clean, dry, soft cotton cloth for cleaning. If your furniture is heavily soiled, you may moisten the cloth with some water or furniture cleaner and dry the cleaned elements afterwards. Metal and glass components are best cleaned with conventional metal and glass cleaners according to the instructions provided for them. The cleaning agents must be clearly identified as being suitable for furniture care. Do not use steam cleaners, corrosive, scouring cleaning agents or other cleaners with unknown effects under any circumstances. ATTENTION: High-gloss surfaces are covered by a protective film on delivery. Leave this on the furniture until it has been fully assembled and dusted. Once the protective film is removed, high-gloss elements may only be cleaned and used after 72 hours (time for post-curing in room air). Do not damage surfaces with sharp objects and never expose them to strong sunlight.</p> <p>DISPOSAL - Notes on waste disposal - For the good of the environment, please sort the packaging for disposal, use the waste/recycling bins provided and do not litter. Damaged or unusable furniture can be recycled by special facilities for the recycling of components. Disused furniture that is still functional does not have to be discarded. Consider donating it to a charitable organisation.</p> <p>We hope you enjoy your new furniture.</p>	<p>Estimado/a cliente: Le damos las gracias por haber adquirido un mueble de nuestra gama de interiores para uso exclusivo en espacios privados. Le rogamos que compruebe que el volumen de suministro esté completo, lea detenidamente la siguiente información importante antes del montaje y la conserve para su uso posterior, también por parte de terceros. Nuestros muebles deben utilizarse según el uso previsto. Un uso inadecuado puede provocar daños materiales o, en determinadas circunstancias, lesiones personales. Los muebles no son juguetes. El fabricante o el distribuidor no asumen ninguna responsabilidad por los daños causados por un uso no conforme al previsto o una manipulación incorrecta. CUIDADO: Los niños o las personas con discapacidades mentales deben mantenerse siempre alejados de los muebles, los objetos afilados, las piezas pequeñas y los materiales de embalaje; existe riesgo de lesiones y/o asfixia. MONTAJE: Para el montaje, siga nuestras instrucciones de uso, instalación o montaje y preste especial atención a las indicaciones de advertencia y seguridad. Si no se siguen las instrucciones, pueden producirse lesiones personales o daños en los muebles/riesgo de seguridad. Si tiene alguna dificultad durante el montaje/la instalación, póngase en contacto con nuestro equipo de atención al cliente. Este estará a su disposición para lo que necesite. El montaje solo deben realizarlo personas competentes. No se asume ninguna responsabilidad por daños en caso de modificaciones en el producto/las piezas del producto ni en caso de sustitución o uso de piezas/consumibles que no procedan del fabricante/distribuidor. Si la mercancía incluye fijaciones de pared, como tacos y tornillos, se utilizarán exclusivamente en paredes hechas con materiales sólidos y uniformes. Una fijación es tan buena como la conexión existente entre los elementos de fijación y la pared. Tanto para los muebles de pie como para los muebles altos, compruebe la idoneidad de la pared antes de fijarlos y utilice únicamente elementos de fijación adecuados. Si tiene que taladrar la pared, asegúrese de que no haya líneas de electricidad en la zona donde vaya a realizar los taladros. En última instancia, el instalador es responsable de la fijación a la pared. Esto también se aplica a la instalación de aparatos eléctricos y otros accesorios de construcción. El montaje/la instalación de aparatos eléctricos y otros accesorios relevantes para la construcción corresponden exclusivamente a personal especializado y autorizado. Todas las instalaciones eléctricas y estructurales deben realizarse de acuerdo con las normas y reglamentos de seguridad aplicables en su región. Asegúrese de que las bombillas utilizadas para las fuentes de luz tengan siempre la intensidad permitida. Si no se respeta el número de vatios máx., existe peligro de incendio por sobrecalentamiento. Se prohíbe cubrir las bombillas debido al peligro de incendio que esto supone. El correcto funcionamiento del mueble solo está garantizado si se instala a plomo y en horizontal. Las puertas están preajustadas, pero deben volver a alinearse/ajustarse en caso necesario según las condiciones locales. Es imprescindible tener en cuenta las indicaciones sobre la carga máxima. Se prohíbe subir a los muebles. En caso de uso inadecuado, los muebles pueden volcarse. Para evitarlo, se recomienda asegurar siempre los muebles para que no se caigan. En caso de sobrecargas (especialmente, por niños jugando, personas, material u otros factores inadecuados), existe riesgo de rotura y lesiones. Se recomienda apretar todos los tornillos y todos los puntos de unión sometidos a carga cada 5 o 6 semanas para garantizar una estabilidad duradera. CUIDADO: -Instrucciones para el cuidado de los muebles- Tenga en cuenta nuestras indicaciones sobre el correcto cuidado de los muebles para que pueda disfrutar de nuestro producto durante el mayor tiempo posible. Para la limpieza, utilice un paño de algodón limpio, seco y suave. Si sus muebles necesitan una limpieza a fondo, puede humedecer el paño con un poco de agua o limpiavuelos y secar los muebles una vez limpios. Para limpiar las piezas de metal y cristal, lo mejor es utilizar productos de limpieza para metal y cristal disponibles en el mercado siguiendo las instrucciones de cuidado que figuran en ellos. Los productos de limpieza deben indicar claramente que son aptos para el cuidado de muebles. No utilice nunca limpiadores de vapor ni productos corrosivos, abrasivos o de otro tipo cuyos efectos desconozca. CUIDADO: Las superficies de alto brillo están protegidas por una película protectora en el momento de la entrega. Déjela en el mueble hasta que este esté completamente montado y libre de polvo. Los elementos de alto brillo a los que se les ha retirado la película protectora solo pueden limpiarse y utilizarse después de 72 horas (tiempo de poscurado en aire ambiente). No dañará las superficies con objetos afilados ni exponerlas a la luz solar fuerte bajo ninguna circunstancia. ELIMINACIÓN -Instrucciones sobre la eliminación de residuos- Por el bien del medioambiente, le rogamos que deposite los residuos de los envases clasificados por tipo en los contenedores de basur/reciclaje previstos, y no en la naturaleza. Los muebles dañados o inutilizables pueden llevarse a puntos de recogida especiales para el reciclaje de sus distintos componentes. Los muebles que estén desgastados, pero sin siendo funcionales no tienen por qué eliminarse. Puede llevarlos, por ejemplo, a organizaciones benéficas.</p> <p>Esperamos que disfrute de su mueble nuevo.</p>	<p>Lugupeetud klient, Täname, et ostsite meie interjööiprogrammist mööbli, mis on mõeldud kasutamiseks ainult eraruumides. Palun kontrollige tame täielikkust, lugege enne kokupanekut hoolikalt läbi järgmine oluline teave ja säilitage see tulevaks kasutamiseks, ka kolmandatele isikutele. Meie mööblit tohib kasutada ainult ettenähtud viisil. Ebaõige kasutamine võib teatud asjaoludel põhjustada varakahjustusi või kehavigastusi. Mööbel ei ole mänguasi. Tootja või turustaja ei vastuta kahjude eest, mis on põhjustatud mitteshipparasest kasutamisest või ebaõigest käsitsemisest. TÄHELEPANU: Lapsed või vaimse puudega isikud tuleb alati hoida eemal mööblidetailedest, teravatest esemetest, väikestest osadest ja pakkematerjalidest. Esineb vigastuse ja/või lämbumisoht. KOOSTAMINE: Järgige meie kasutus-, monteerimis- või paigaldusjuhiseid ning järgige eelkõige hoiatusi ja ohutusjuhiseid. Juhiste eiramine võib põhjustada kehavigastusi või mõeldi kahjustamist ning ohustada ohutust. Kui teil on sobimatuid/monteerimisel probleeme, võtke ühendust meie teenindusmeeskonnaga. Nad aitavad teid hea meelega. Monteerimist võivad läbi viia ainult pädevad isikud. Toote/toote komponentide muudatuste või tootja/müüja poolt tarnimata osade/tarvikute asendamise/kasutamise korral ei võeta vastutust kahjude eest. Kui tootega on kaasas seinakinnitusmaterjalid, nagu tüübid või kruvid, on need ette nähtud kasutamiseks ainult ühtlastest materjalidest valmistatud tugevatel seintel. Kinnitus on nii hea kui kinnitusmaterjalide ja seina vaheline ühendus. Niisiis vaata ka ripputa mööbli puhul kontrollige enne kinnitamist oma seina sobivust ja kasutage ainult sobivaid kinnitusmaterjale. Enne aukude puurimist veenduge, et puuritsoonis ei oleks jooni. Lõppkokkuvõttes vastutab paigaldaja seinale kinnitamise eest. See kehtib ka elektriseadmete ja muude konstruktsioonitarvikute paigaldamise kohta. Elektriseadmete ja muude konstruktsioonitarvikute kokkupaneku/paigaldamist tohib teostada ainult selleks volitatud kvalifitseeritud töötajad. Kõik elektri- ja konstruktsioonipaigaldised tuleb teostada vastavalt teie liidumaa vastavatele kehtivatele standarditele ja ohutusesekirjadele. Kasutage valgusallikate jaoks ainult heakskiidetud valgusteid. Maksimaalse võimsuse ülendamisel on ülekuumenemise ja tulekahju oht. Valgustusainete kahmine on talleohu tõttu keelatud. Mööbli nõuetekohane toimimine eeldab loodis- ja horisontaaljoonset. Üksed on eelnevalt reguleeritud, kuid kohalike olude tõttu võivad need vajada uuesti reguleerimist. Järgige kindlasti maksimaalset koormuste kaalutsesfiikatsiooni. Mööblile ronimine on keelatud. Mööbel võib vale kasutamine korral ümber kukkuda. Selle vältimiseks tuleks mööbel alati ümberkukkumise vastu kindlustada. Ülekoormamisel (eriti laste, inimeste, materjalide või muude keelatud koormate mängimisel) on purunemise ja vigastuste oht. Kõik kruvid ja kandvad ühendused tuleb 5–6 nädala pärast uuesti kinni keerata, et tagada püsiv stabiilsus. HOOLDUS: - Märkused mööbli hooldamise kohta - Järgige meie teavet õige mööblihoolduse kohta, et saaksite meie toodet pikka aega nautida. Kasutage puhastamiseks puhast, kuiva pehmet puuvillast lappi. Kui teile mööbel on tugevalt määrunud, võite lappi niisutada mõne vee või mööblipuhastusvahendiga ja seejärel kuivatada puhastatud elemendid. Metall- ja klaaskomponente on kõige parem puhastada tavalist metalli- ja klaasipuhastusvahenditega vastavalt neile antud juhistele. Puhastusvahendid peavad olema selgelt identifitseeritud kui sobivad mööbli hooldamiseks. Ärge mingil juhul kasutage aurupuhastajaid, söövitavaid, küürivaid puhastusvahendeid ega muid tundmatu toimega puhastusvahendeid. TÄHELEPANU: Kõrgläägiga pinnad on tarmimisel kaetud kaitsekilega. Jätke see mööblile, kuni see on täielikult kokku pandud ja tolmust puhastatud. Kui kaitsekile on eemaldatud, võib kõrgläägiga elemente puhastada ja kasutada alles 72 tunni pärast (toaõhus järelkõvenemise aeg). Ärge kahjustage pindu teravate esemetega ja ärge kunagi jätke neid tugeva päikesevalguse kätte.</p> <p>KÕRVALDAMINE - Märkused jäätmete kõrvaldamise kohta - Keskkonna hüvanguks palume pakendit utilitseerimiseks sorteerida, kasutada kaasasolevaid jäätme-/prügikaste ning mitte prügi maha visata. Kahjustatud või kasutuskoilmatud mööblit saab taaskasutada spetsiaalses komponendis ringlussevõtu rajatistes. Kasutamata mööblit, mis on endiselt funktsionaalne, ei pea ära viskama. Kaaluge selle annetamist heategevusorganisatsioonile.</p> <p>Loodame, et naudite oma uut mööblit.</p>	<p>Chères clientes, chers clients, merci d'avoir acheté un meuble de notre gamme Espace intérieur pour l'usage exclusif dans des locaux privés. Veuillez vérifier que le contenu de la livraison est complet et lire attentivement les informations importantes ci-dessous avant le montage, et conservez-les soigneusement pour d'éventuelles applications/utilisations ultérieures, y compris par des tiers. Nos meubles doivent être utilisés de manière conforme à leur destination. Une utilisation non conforme à la destination peut entraîner des dommages matériels ou dans certains cas des préjudices corporels. Les meubles ne sont pas des jouets destinés aux enfants. Le fabricant ou le distributeur décline toute responsabilité pour des dommages résultant d'une utilisation non conforme ou d'une manipulation erronée. ATTENTION: Les enfants et les personnes handicapées mentales doivent toujours être tenus à distance des éléments de mobilier, des objets pointus, des petites pièces et des matériaux d'emballage en raison d'un risque de blessure et/ou d'étouffement. MONTAGE: Lors du montage, veuillez suivre notre mode d'emploi, nos instructions d'exploitation, d'installation ou de montage et respectez notamment les avertissements et consignes de sécurité. Le non-respect des consignes peut entraîner des blessures des personnes ou des endommagements du meuble, constituer un risque pour la sécurité. Si vous rencontrez des difficultés de montage/ assemblage, veuillez contacter notre équipe de service clientèle. Elle est à votre entière disposition pour vous aider et vous conseiller. Le montage doit être effectué uniquement par des personnes qualifiées. Aucune responsabilité ne peut être assumée pour des dommages résultant de modifications apportées au produit ou à des parties du produit, du remplacement ou de l'utilisation de pièces/de fournitures qui n'ont pas été acquises auprès du fabricant/ du distributeur. Lorsque le produit est accompagné d'éléments de fixation murale tels que des chevilles et des vis, ces éléments sont exclusivement destinés à être utilisés sur des murs en matériaux massifs et homogènes. Une fixation n'est bonne que si la liaison entre les éléments de fixation et le mur est bonne. Avant la fixation au mur de meubles, qu'ils soient posés verticalement ou suspendus, veuillez vérifier l'aptitude de votre mur à cet effet et n'utiliser que des moyens de fixation appropriés. Avant de procéder à des travaux de perçement, assurez-vous qu'il n'y a pas de conduites dans la zone de perçement. En dernier ressort, c'est le monteur qui est responsable de la fixation au mur. Cela concerne également l'installation d'appareils électriques et autres accessoires architectoniques. L'assemblage / l'installation d'appareils électriques et autres accessoires de construction ne doivent être effectués que par un personnel autorisé. Toutes les installations électriques et architectoniques doivent être exécutées dans le respect des normes et règles de sécurité en vigueur de votre Land. Concernant les lumineuses, n'utilisez que des puissances d'ampoules autorisées. En cas de non-respect du wattage maximal, il existe un risque d'incendie par surchauffe. Il est interdit de recouvrir les ampoules en raison du risque d'incendie. Le fonctionnement sans problème du meuble n'est garanti qu'en cas d'installation verticale et horizontale. Les portes sont pré réglées, mais doivent être re-alignées / ajustées si nécessaire en fonction des conditions locales. Respectez impérativement les spécifications en matière de poids concernant la charge maximale. Il est interdit de monter sur les meubles. En cas d'utilisation non conforme, il peut arriver que les meubles basculent. Afin d'éviter ce risque, les meubles doivent toujours être sécurisés contre le basculement. Il existe un risque de rupture et de blessure en cas de surcharges/ sollicitations excessives (notamment causées par des enfants qui jouent, des personnes, du matériel ou d'autres influences inappropriées). Afin de garantir une stabilité durable, toutes les vis et les points de raccordement portes doivent être resserrés après 5 à 6 semaines. ENTRETIEN: -Consignes d'entretien du mobilier- Veuillez respecter nos instructions pour l'entretien correct du meuble afin que vous profitiez le plus longtemps possible de notre produit. Pour le nettoyage, utilisez un chiffon en coton propre, sec et doux. Si vos meubles ont besoin d'un nettoyage approfondi, vous pouvez humidifier le chiffon avec un peu d'eau et sécher ensuite les éléments nettoyés. Pour les parties en métal et en verre, il est préférable d'utiliser les produits de nettoyage usuels du commerce pour le métal et les vitres en respectant les conseils d'entretien indiqués sur ces produits. Ces produits de nettoyage doivent clairement porter la mention indiquant qu'ils sont appropriés pour l'entretien des meubles. N'utilisez en aucun cas de nettoyeur à vapeur, ni de produits corrosifs, abrasifs et autres produits dont vous ne connaissez pas les effets. ATTENTION: Lors de la livraison, les surfaces haute brillance sont protégées par un film de protection. Laissez-les sur le meuble jusqu'à ce qu'il soit totalement monté et débarrassé de la poussière. Les éléments haute brillance dont le film protecteur a été enlevé ne doivent être nettoyés et utilisés qu'après 72 heures (temps de durcissement à l'air ambiant). Ne pas endommager les surfaces avec des objets acérés et ne les exposez en aucun cas à un rayonnement solaire intense. ÉLIMINATION -Consignes pour l'élimination des déchets- Afin de protéger l'environnement, veuillez éliminer les déchets d'emballage triés selon leur nature dans les poubelles de déchets/de recyclage et non dans la nature. Les meubles endommagés ou inutilisables peuvent être amenés dans des centres de récupération aux fins du recyclage des pièces détachées. Les meubles usagés, mais encore fonctionnels ne doivent pas être éliminés tout de suite. Faites-en don p. ex. à des organisations de bienfaisance.</p> <p>Nous vous souhaitons beaucoup de plaisir avec votre nouveau meuble.</p>

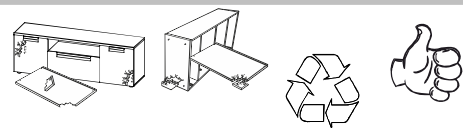
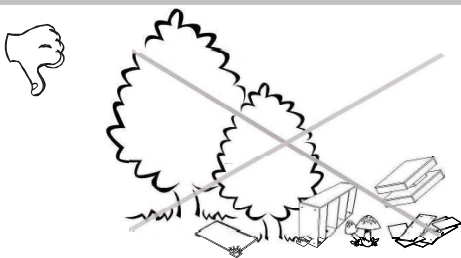
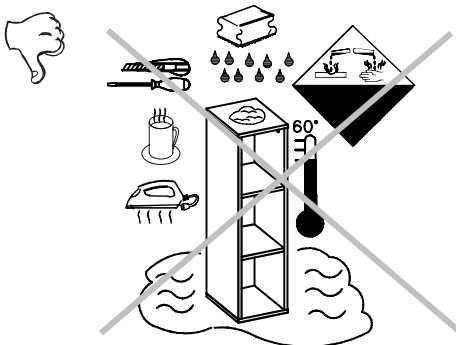
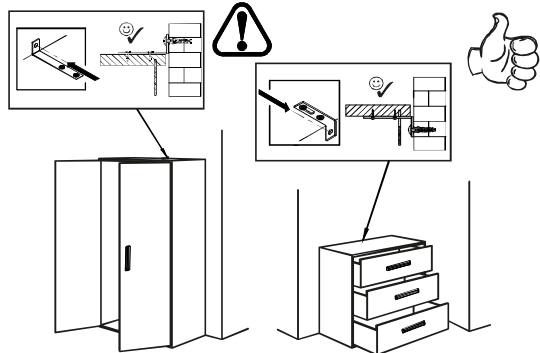
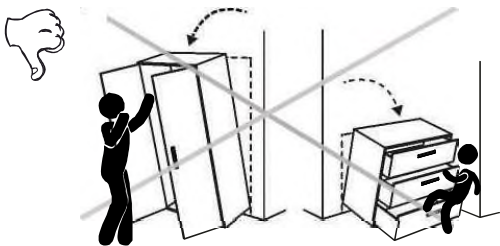
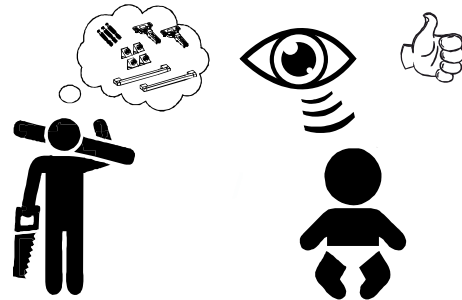
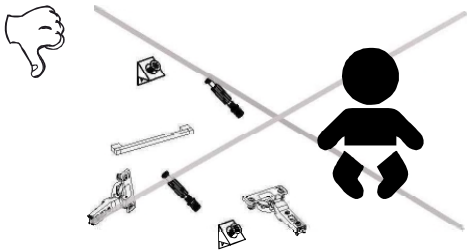
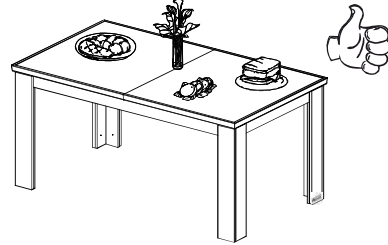
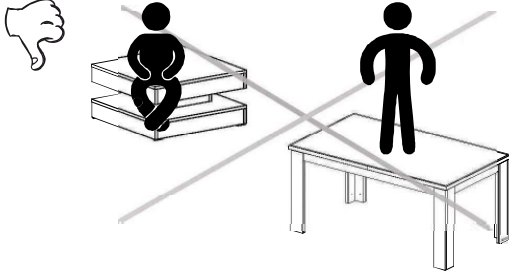
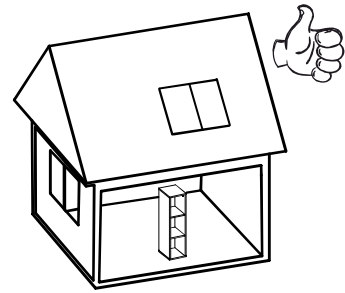
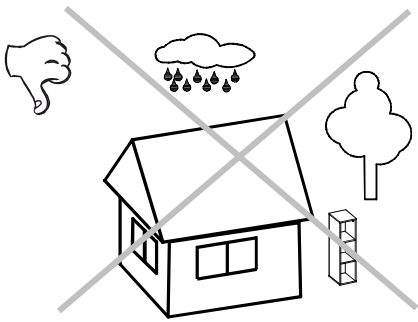

1

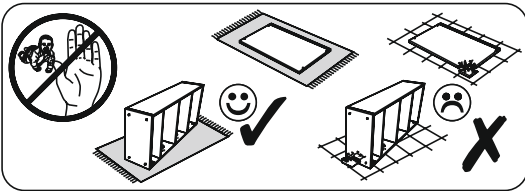

DA70		3x14	x12
T51			x3
D35		4x12	x4

C52			x6
I21			x2

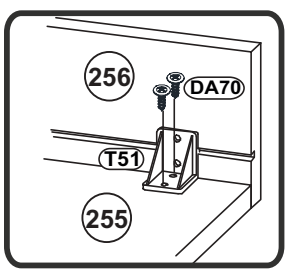
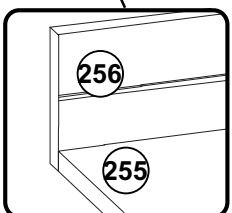
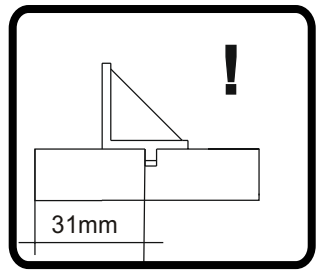
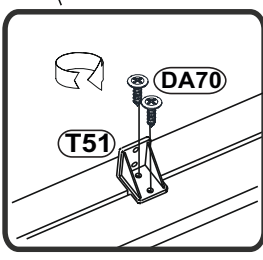
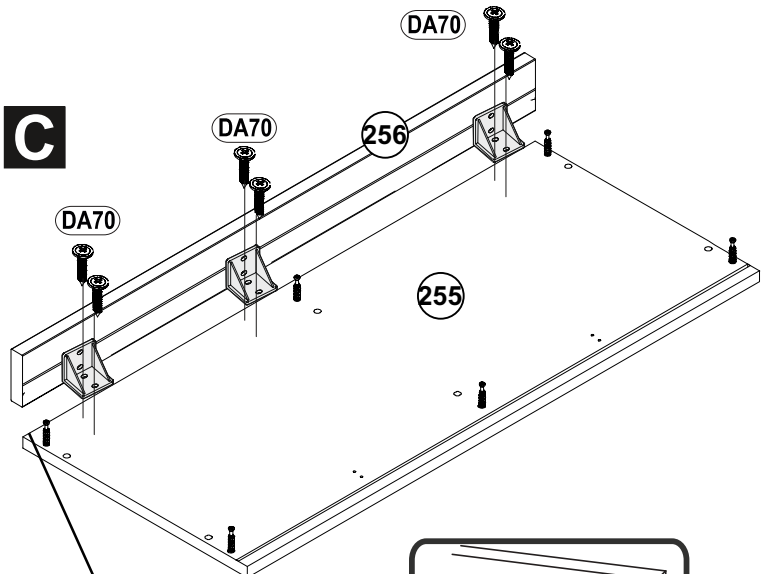
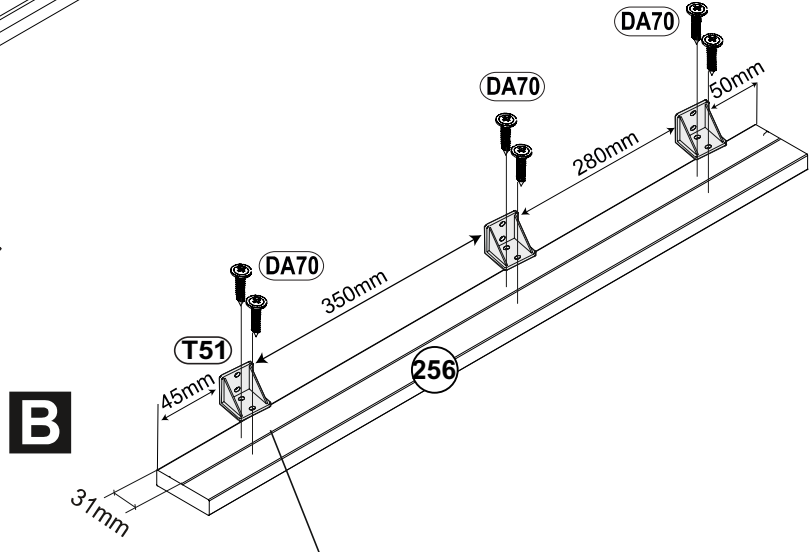
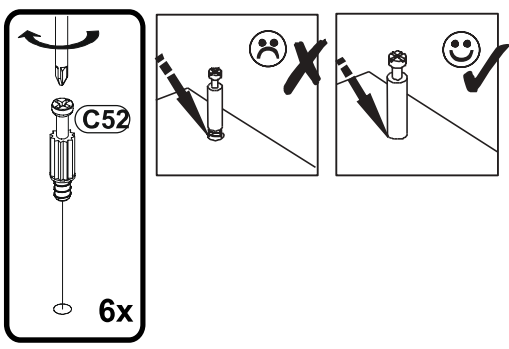
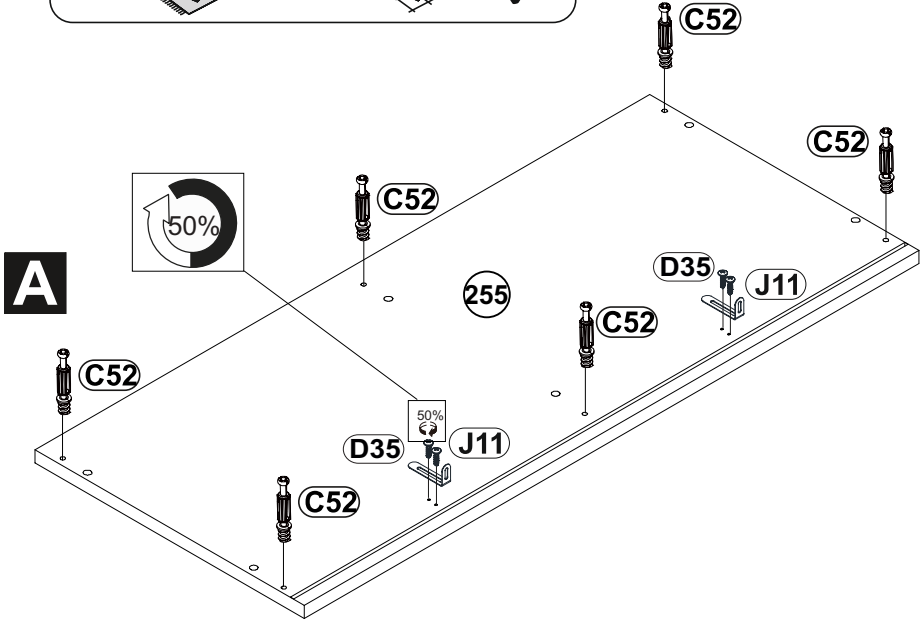

2

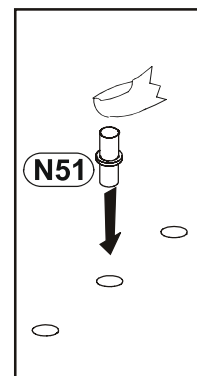
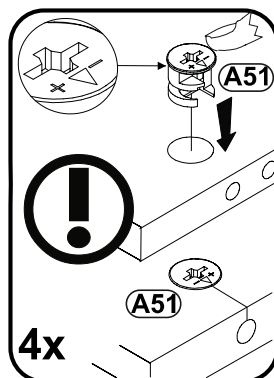
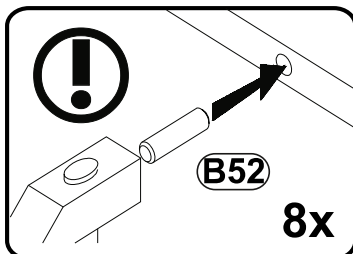
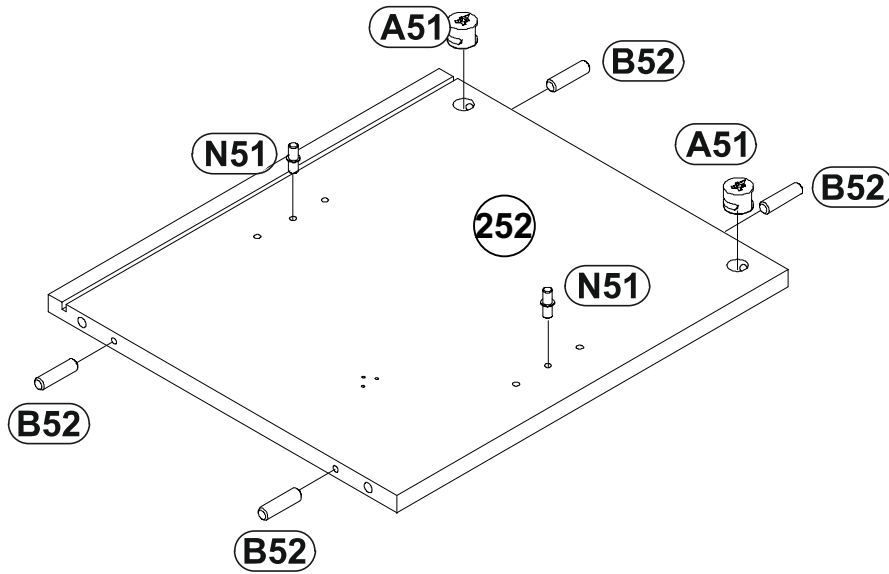
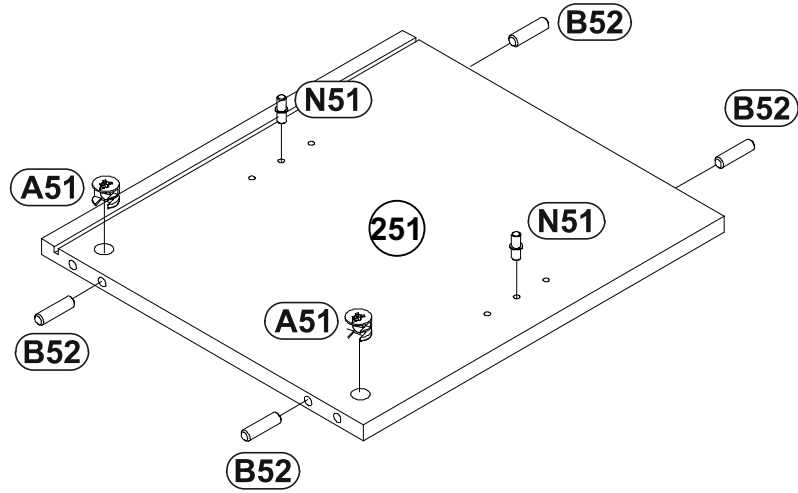
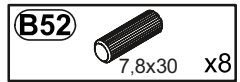
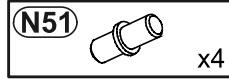
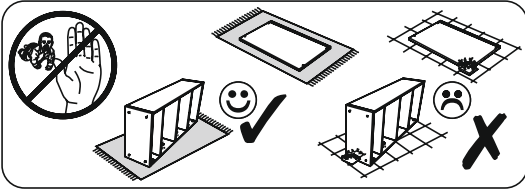

3

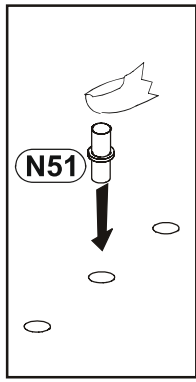
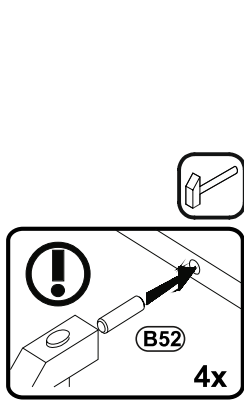
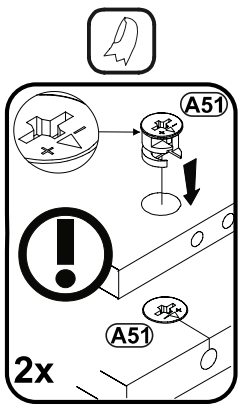
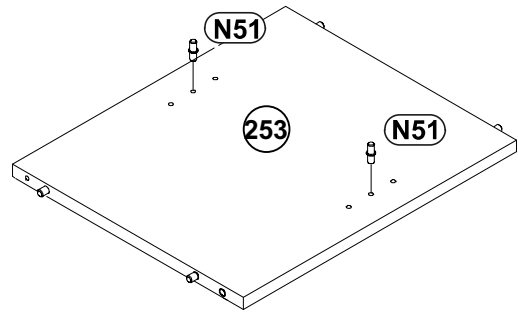
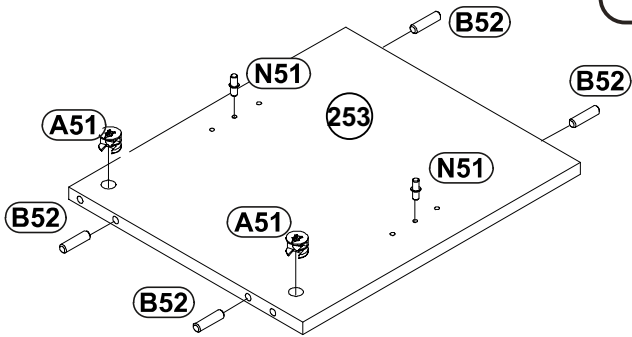
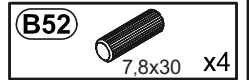
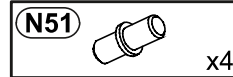
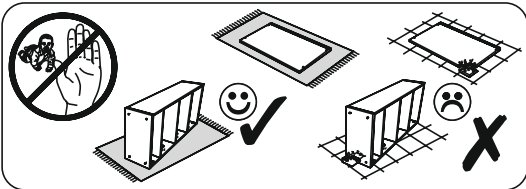

4

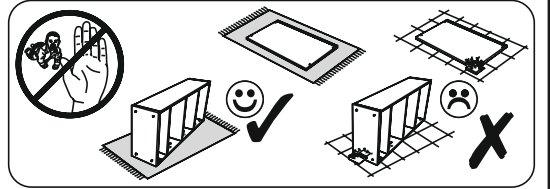
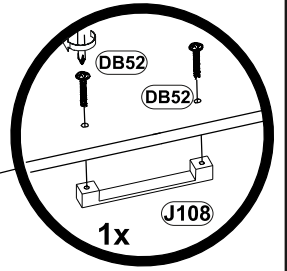
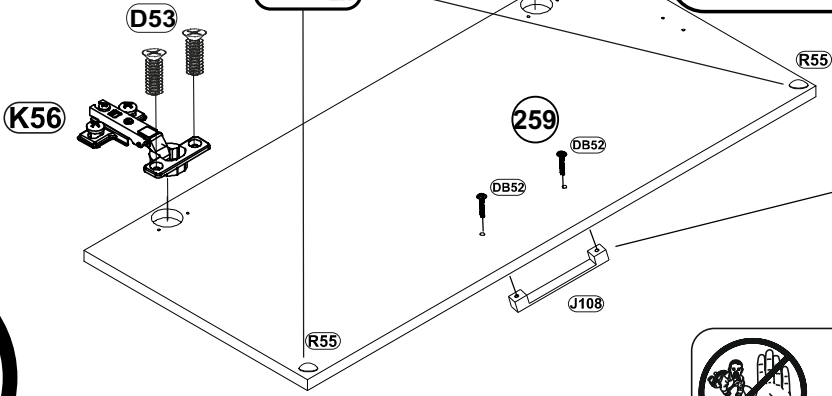
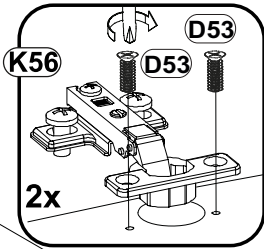
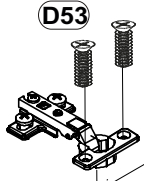
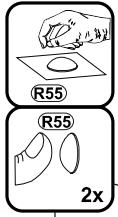
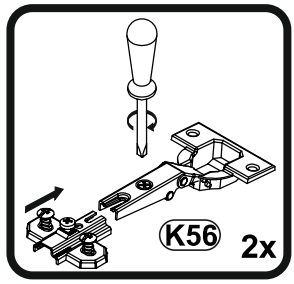
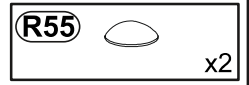
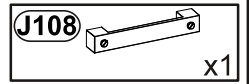
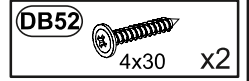
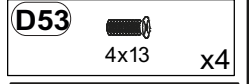
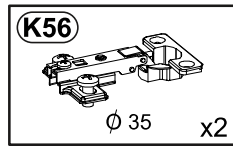
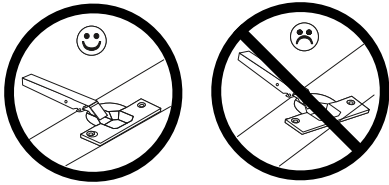

5

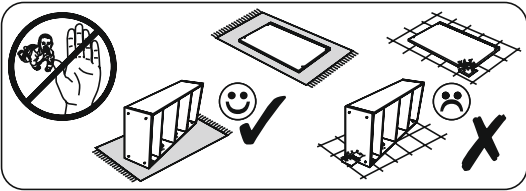

O51 ϕ 17
x6

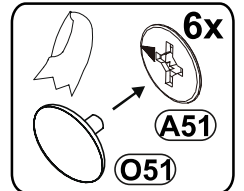
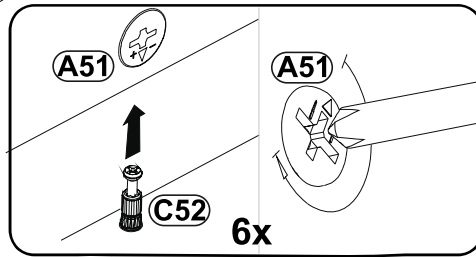
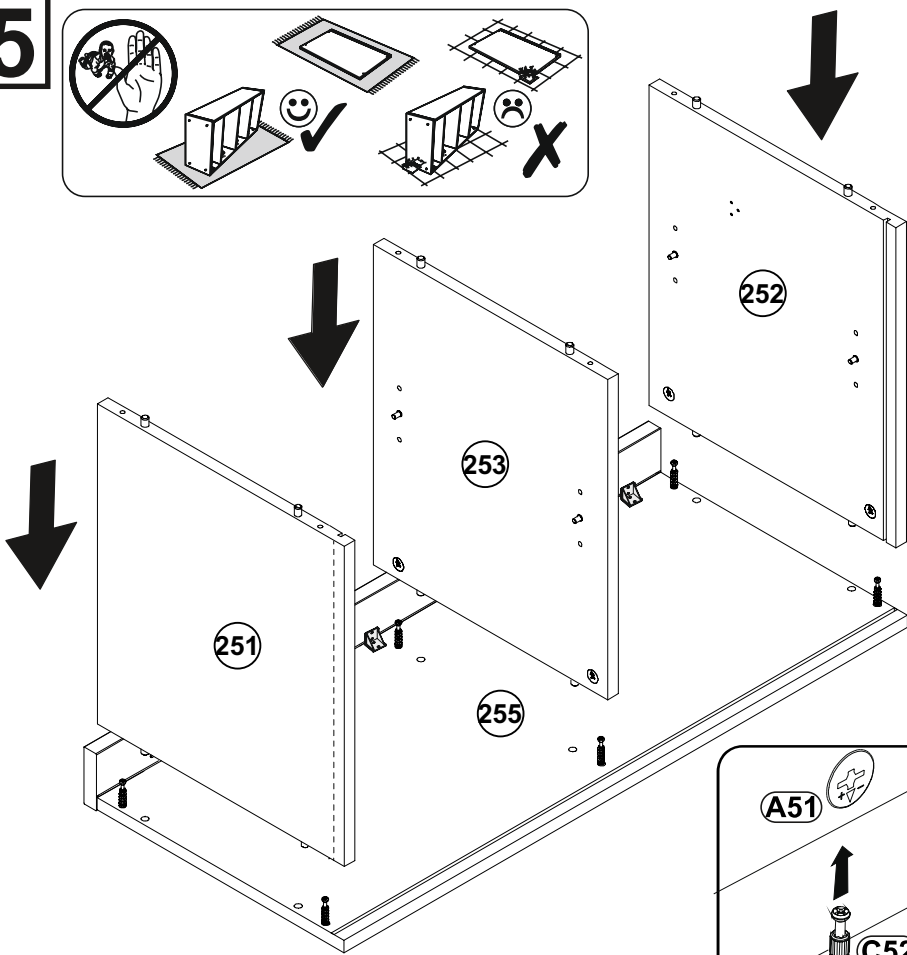

6

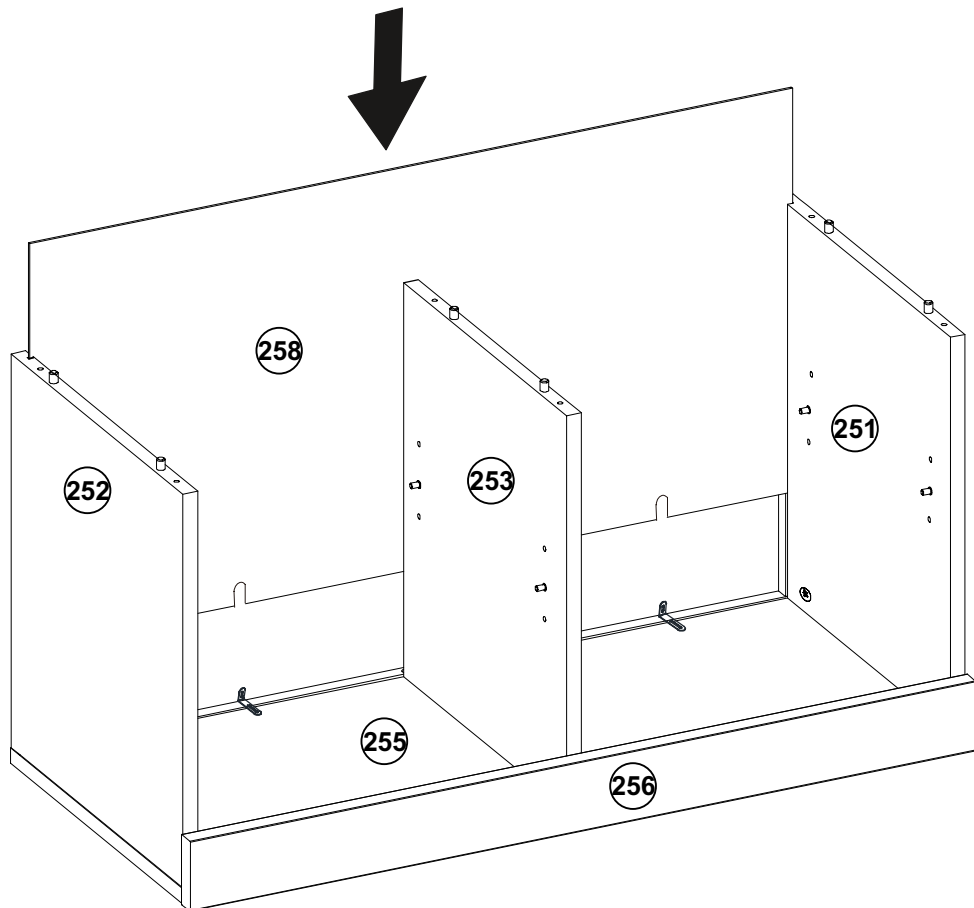

7

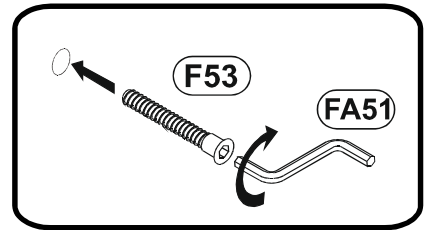
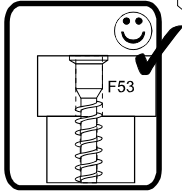
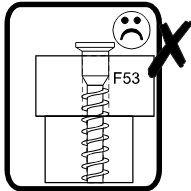
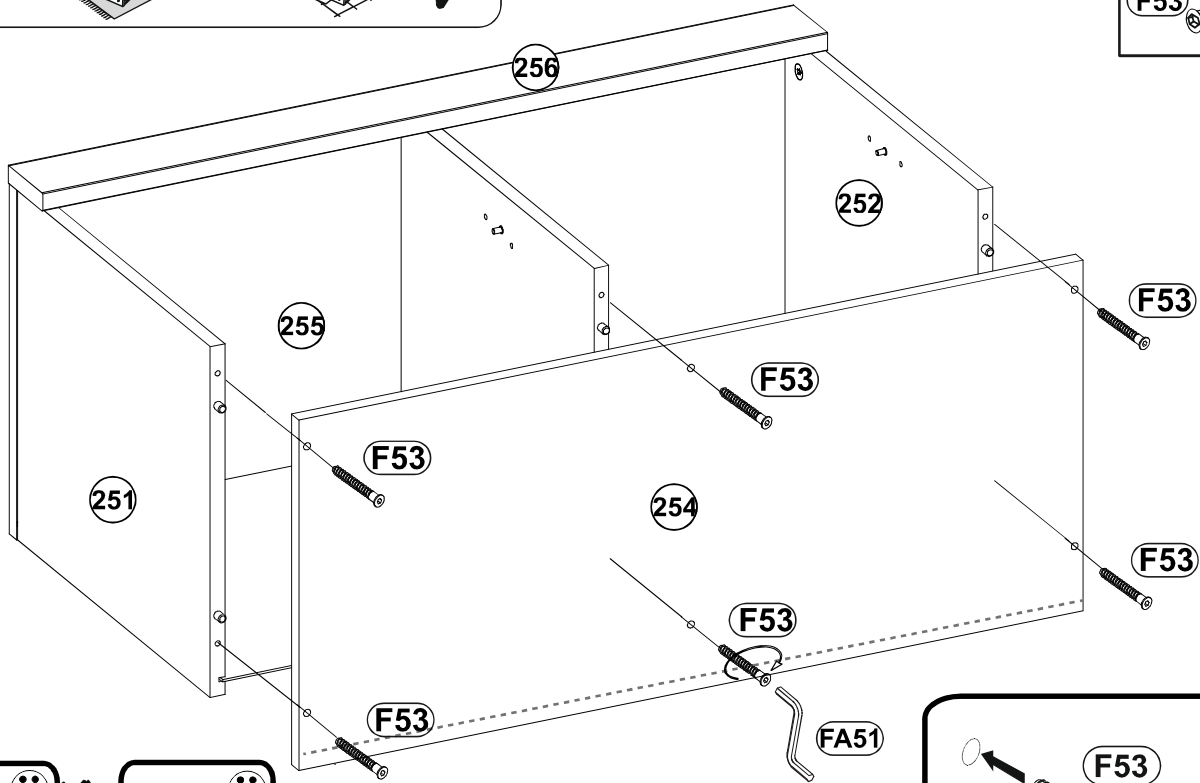
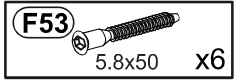
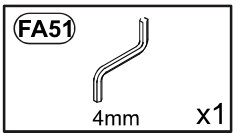
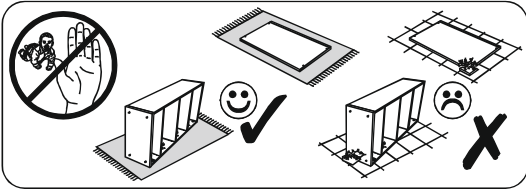

8

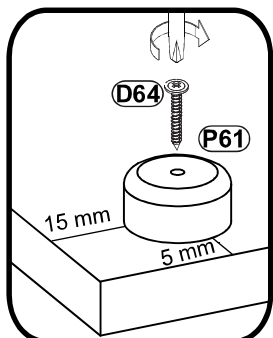
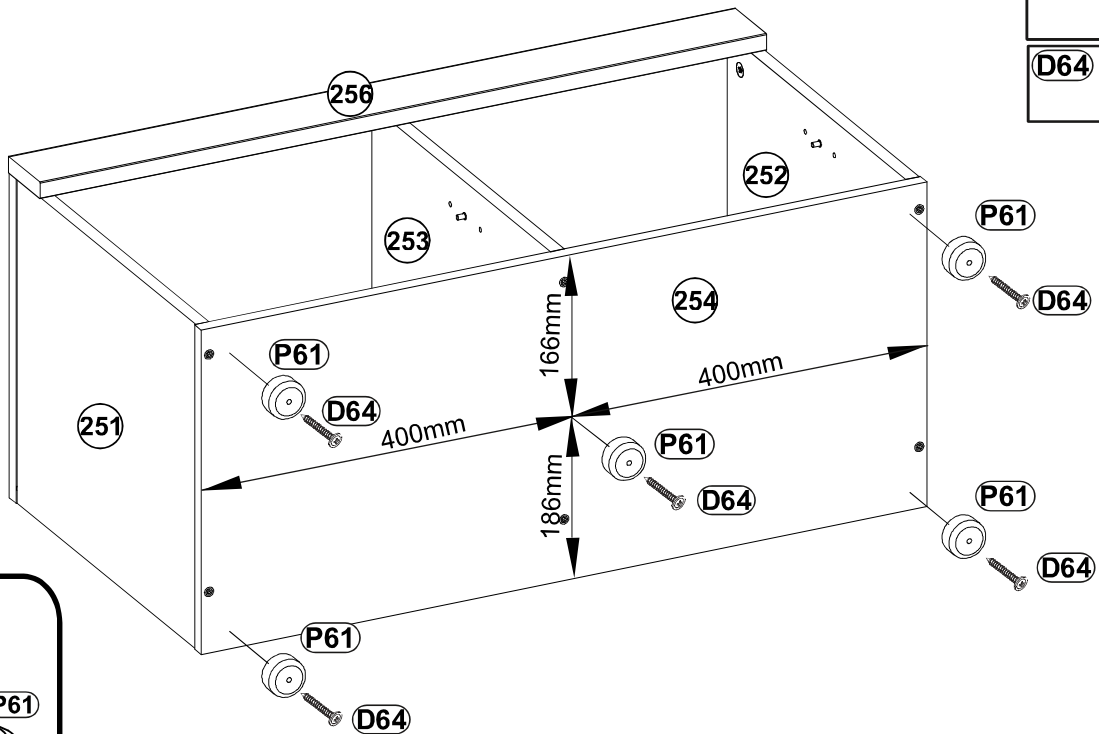
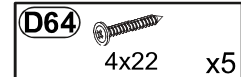
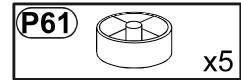

9

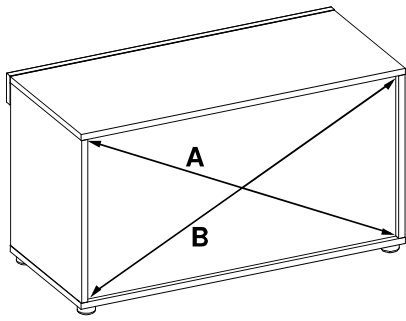

A = B

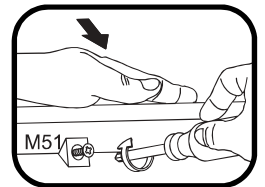
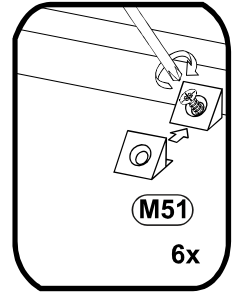
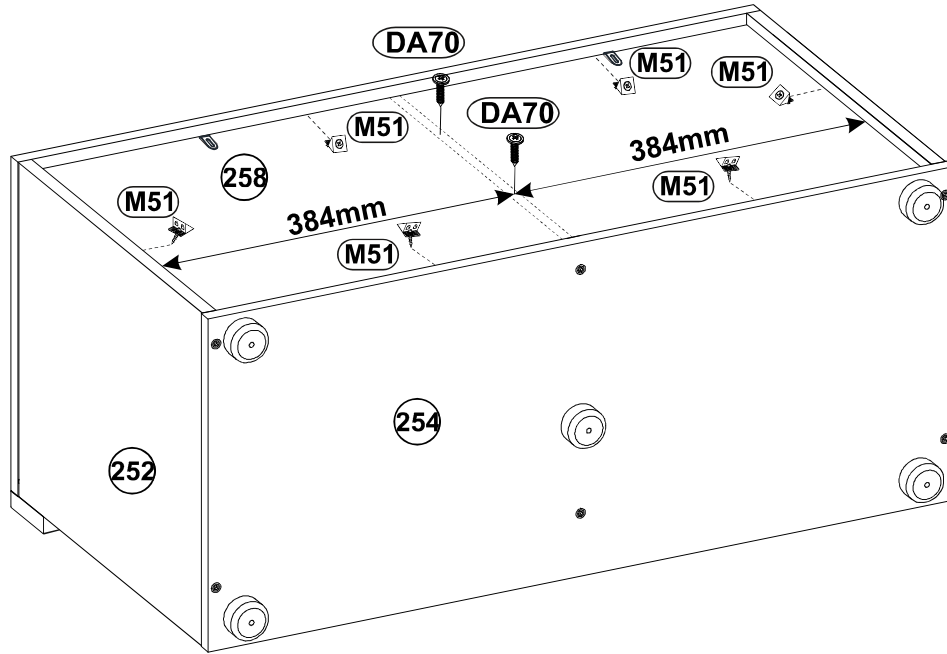
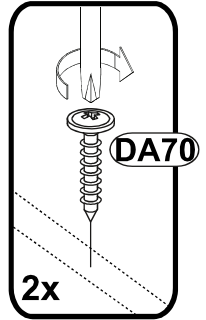
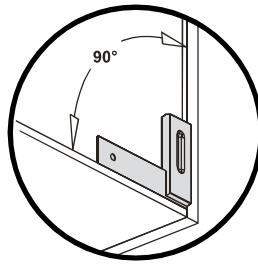

10

